

UM400a

Frequency Synthesized 100 mW UHF Belt-Pack Transmitter



Featuring

Digital Hybrid Wireless[®] Technology

U.S. Patent 7,225,235

Fill in for your records:

Serial Number:

Purchase Date:

Table of Contents

General Technical Description	4
Introduction	4
Digital Hybrid Wireless® Technology	4
UM400a Block Diagram	4
No Pre-Emphasis/De-Emphasis	5
Pilot Tone Squelch	5
Input Limiter	5
Wide-Band Deviation	5
Frequency Selection	5
Controls and Functions	6
Input Jack	6
Power ON/OFF Switch	6
Power On LED	6
Frequency Select Switches	6
Audio Level Control	7
Modulation LEDs	7
Antenna	7
Adjustable Low Frequency Roll-Off	7
Belt Clip	7
Battery Installation	8
Operating Instructions	8
Selecting the Compatibility Mode	8
Attaching a Microphone and Adjusting Gain	9
Operating Notes	9
Adjusting the Transmitter Frequency	9
5-Pin Input Jack Wiring	10
Microphone Cable Termination for Non-Lectrosonics Microphones	11
TA5F Connector Assembly	11
Mic Cord Stripping Instructions	11
Crimping to Shield and Insulation	11
Microphone RF Bypassing	12
Line Level Signals	12
Wiring Hookups for Different Sources	13
Works with Servo Inputs Only:	13
Compatible with Servo Inputs and other Lectrosonics Transmitters:	13
Replacement Parts and Accessories	14
UHF Transmitter Antenna Specifications	14
Troubleshooting	15
Specifications and Features	17
Service and Repair	18
Returning Units for Repair	18

General Technical Description

Introduction

The UM400a transmitter combines 100 mW of RF output with +/-75 kHz wide deviation for extended operating range and extremely high signal to noise ratio. These key design features are coupled with the compandor-free Digital Hybrid Wireless® audio chain and packaged in the widely recognized Lectrosonics standard transmitter housing.

The unit is powered by a single 9V battery in the internal compartment, or from external DC using a Lectrosonics ISO9VOLT battery eliminator.

Digital Hybrid Wireless® Technology

All wireless links suffer from channel noise to some degree, and all wireless microphone systems seek to minimize the impact of that noise on the desired signal. Conventional analog systems use compandors for enhanced signal to noise ratio, at the cost of subtle artifacts (known as “pumping” and “breathing”). Wholly digital systems defeat the noise by sending the audio information in digital form, at the cost of some combination of power, bandwidth and resistance to interference. *US Patent 7,225,135*

Lectrosonics Digital Hybrid Wireless® systems overcome channel noise in a dramatically new way, digitally encoding the audio in the transmitter and decoding it in the receiver, yet still sending the encoded informa-

tion via an analog FM wireless link. This proprietary algorithm is not a digital implementation of an analog compandor but a technique that can be accomplished only in the digital domain, even though the inputs and outputs are analog.

Channel noise still impacts received signal quality and will eventually overwhelm a receiver. Digital Hybrid Wireless® simply encodes the signal to use a noisy channel as efficiently and robustly as possible, yielding audio performance that rivals that of wholly digital systems, without the power and bandwidth problems inherent in digital transmission.

Because it uses an analog FM link, Digital Hybrid Wireless® enjoys all the benefits of conventional FM wireless systems, such as excellent range, efficient use of RF spectrum, and resistance to interference. However, unlike conventional FM systems, it does away with the analog compandor and its artifacts.

No Pre-Emphasis/De-Emphasis

The Digital Hybrid Wireless® design results in a signal-to-noise ratio high enough to preclude the need for conventional pre-emphasis (HF boost) in the transmitter and de-emphasis (HF roll off) in the receiver. This eliminates the potential for extreme distortion on signals with abundant high-frequency information.

UM400a Block Diagram

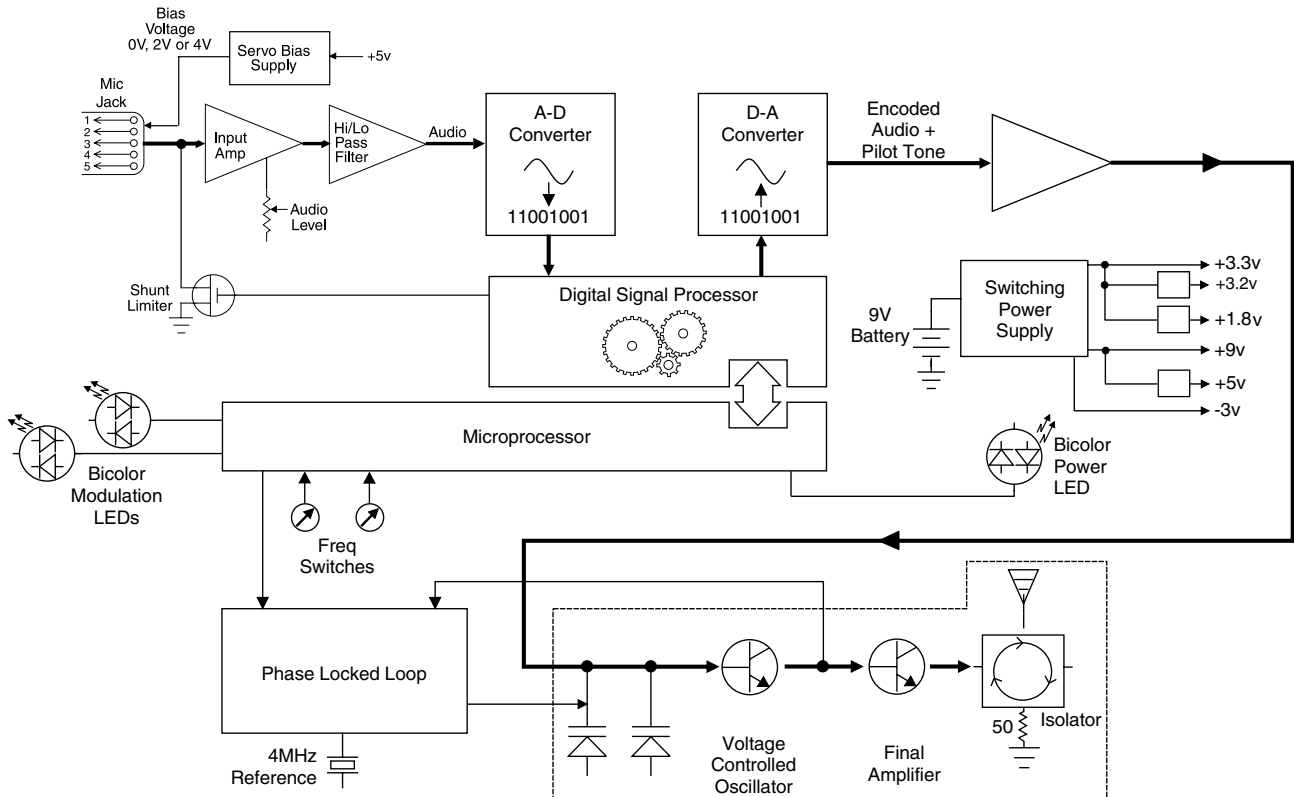

Low Frequency Roll-Off

The low frequency roll-off at the 3 dB down point is variable from 35 to 150 Hz to control subsonic and very low frequency audio content in the audio. The actual roll-off frequency will vary slightly depending upon the low frequency response of the microphone.

Excessive low frequency content can drive the transmitter into limiting, or in the case of high level sound systems, can even cause damage to loudspeaker systems. The roll-off is normally adjusted by ear while listening as the system is operating.

Input Limiter

A DSP-controlled analog audio limiter is employed before the analog-to-digital (A-D) converter. The limiter has a range of more than 30 dB for excellent overload protection. A dual release envelope makes the limiter acoustically transparent while maintaining low distortion. It can be thought of as two limiters in series, a fast attack and release limiter followed by a slow attack and release limiter. The limiter recovers quickly from brief transients, with no audible side effects, and also recovers slowly from sustained high levels, to keep audio distortion low and while preserving short term dynamics.

Signal Encoding and Pilot Tone

In addition to controlling the limiter, the DSP also encodes the digitized audio from the A-D converter and adds an ultrasonic pilot tone to control the receiver's squelch. A pilot tone squelch system provides a reliable method of keeping a receiver output muted (squelched) even in the presence of significant interference. When the system is operating in the hybrid mode, a different pilot tone frequency is generated for each carrier frequency to prevent inadvertent squelch problems and simplify multi-channel coordination.

Microprocessor, PLL and VCO Circuits

A microprocessor monitors user command inputs from the control panel buttons and numerous other internal signals. It works intimately with the DSP to ensure the audio is encoded according to the selected Compatibility Mode and that the correct pilot tone is added to the encoded signal.

Compatibility Modes

Digital Hybrid transmitters were designed to operate with Lectrosonics Digital Hybrid receivers and will yield the best performance when doing so. However, due to the flexibility of digital signal processing, the transmitters can also operate in various compatibility modes for use with Lectrosonics 200 Series, Lectrosonics 100 Series, IFB and certain non-Lectrosonics receivers. Contact the Lectrosonics sales department for a complete list of compatible non-Lectrosonics receivers.

Wide-Band Deviation

± 75 kHz deviation improves the signal to noise ratio and audio dynamic range of a wireless system dramatically, compared to other designs that use ± 30 kHz to 40 kHz deviation. Wide deviation combined with a high powered transmitters makes a significant improvement in signal to noise ratio and operating range.

Battery Options and Operating Time

Switching power supplies convert regulated battery voltages to operate various circuit stages with maximum efficiency. With the variety of alkaline, lithium and rechargeable batteries available today in the 9V format, there are many choices to maximize operating time or minimize cost as needed for any application.

Frequency Blocks

Lectrosonics established a "block" numbering system years ago to organize the range of frequencies available from the low 500 MHz band to the upper 700 MHz band. Each block includes 256 frequencies in 100 kHz increments. The block number is part of a simple formula to derive the frequency. The block number is multiplied by 25.6 to produce the lowest frequency in the block. For example, block 27 x 25.6 = 691.200.

Circulator/Isolator

The RF output circuit includes a one way circulator/isolator using a magnetically polarized ferrite. This device greatly reduces the RF intermodulation produced when multiple transmitters are used in close proximity to one another (several feet apart). The isolator also provides additional RF output stage protection.

Controls and Functions



Input Jack

The input on the UM400a accommodates virtually every lavalier, hand-held or shotgun microphone available. Different line level signals can also be accommodated. (See Wiring Hookups for Different Sources.)

Power ON/OFF Switch

Turns the transmitter on and off. Even when the switch is turned off or on abruptly, the pilot tone muting system prevents “thumps” or transients from occurring.

Power On LED

The Power LED glows green when the battery is good and the transmitter is turned on. The LED will glow yellow/orange as the battery voltage drops and finally glows red when there are about 30 minutes of operation left (when using the recommended battery). The LED blinks red when there are only a few minutes of life left.

NOTE: While a NiMH battery provides long operating time, it will give little or no warning before it is depleted. If you use a NiMH battery in the UM400a, we recommend trying a fully charged battery in the unit, noting the length of time that it will run the unit, and in the future use somewhat less than that time to determine when the battery needs to be replaced. Digital Hybrid receivers include timers to accurately track battery usage.

A weak battery will sometimes light the Power LED to the “good” green indication immediately after being put in the unit, but will quickly discharge to the point where the LED will go red or shut down (just like a flashlight with “dead” batteries). If the lamp fails to light, the battery should be replaced.

Frequency Select Switches

Two 16-position rotary switches adjust the center frequency of the carrier. The left-hand switch 1.6 MHz steps and the right-hand switch makes 100K steps.

Audio Level Control

The front panel AUDIO LEVEL Control is used to adjust the input level (gain) for optimal modulation. The controls provides continuously variable gain over a 43 dB range for precise adjustment.

Modulation LEDs

The Modulation LEDs provide a visual indication of the input audio signal level from the microphone. These two bicolor LEDs can glow either red or green to indicate modulation levels.

Signal Level	-20 LED	-10 LED
Less than -20 dB	○ Off	○ Off
-20 dB to -10 dB	● Green	○ Off
-10 dB to +0 dB	● Green	● Green
+0 dB to +10 dB	● Red	● Green
Greater than +10 dB	● Red	● Red

The Modulation LEDs also indicate the Compatibility Mode when the transmitter power switch is turned on. The LEDs will blink simultaneously to indicate the mode currently set:

- Once for 100 Series mode
- Two times for 200 Series mode
- Three times for mode 3
- Four times for Digital Hybrid Wireless (also called the 400 Series mode)
- Five times for IFB mode (not available on very early units)
- Six times for mode 6

Modes 3 and 6 provide compatibility with other manufacturer's receivers - contact the factory for details.

Antenna

The flexible steel cable antenna supplied with the transmitter is cut to 1/4 wavelength of the center of the frequency block (the frequency range) of the transmitter. The SMA connector is a 50 Ohm RF port which can also be connected directly to test equipment. Replacement antennas are available in pre-cut lengths for specific frequency blocks, or as a kit with instructions to cut the antenna for any frequency block.

Adjustable Low Frequency Roll-Off

The low frequency roll-off control is used to remove subsonic (or very low frequency) audio, often produced by air conditioning systems, automobile traffic and other sources. Excessive low frequency content in the audio input can cause a variety of audio problems including driving the transmitter into limiting. In sound reinforcement systems, as one instance, excessive low frequency content can cause excessive power amplifier drain or even damage to loudspeaker systems.

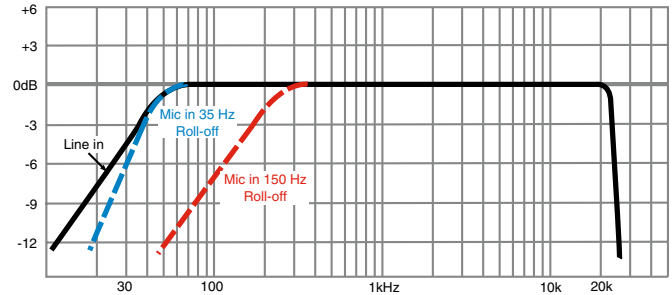

The side panel is marked to indicate the approximate hinge point of the roll-off, but is normally adjusted while listening to the audio. In controlled situations, such as a motion picture production set indoors where environmental noise is minimal, the control can be rotated counter-clockwise to permit low frequency audio to be captured.

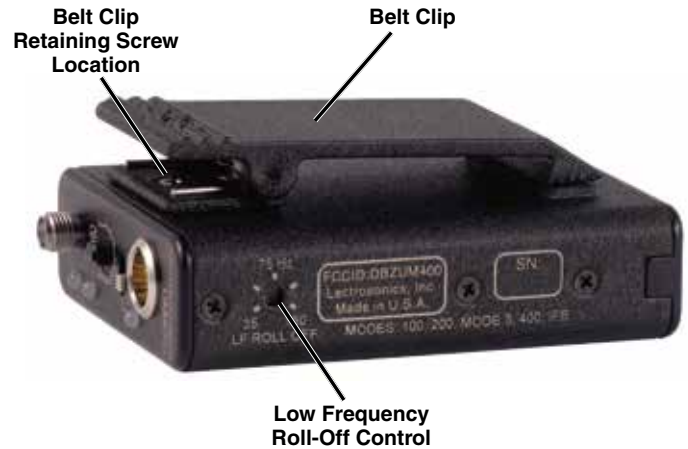

Belt Clip

The belt clip may be removed for special applications by removing one screw.

WARNING: Use ONLY the screw that is supplied.

The circuitry is tightly fitted into this unit. A longer screw will permanently damage the transmitter!

Battery Installation

To open the battery compartment, press outward on the cover door in the direction of the arrow as shown in the illustration. Only firm, sliding pressure is needed to open and close the battery door. Swing the door open and take note of the polarity marked inside showing the location of the positive (+) and negative (-) terminals. You can also see the large and small contact holes inside the battery compartment with the door open.

Insert the battery correctly and close the cover by pressing the door closed and across, reversing the opening procedure illustrated here. If the battery is inserted incorrectly, the door will not close. Do not force the door closed.



Operating Instructions

Selecting the Compatibility Mode

The UM400a can be used with Lectrosonics 400 Series Digital Hybrid, 200 Series analog, 100 Series analog, Lectrosonics IFB and some non-Lectrosonics analog wireless receivers. Contact the factory for details on the non-Lectrosonics models that can be used. The transmitter must be set to the operating mode of the matching receiver, which is done using the supplied screwdriver and a battery.

NOTE: The unit is supplied from the factory as a Digital Hybrid (400 series) transmitter.

- 1) Ensure the battery is good.
- 2) Turn off the transmitter.
- 3) With a small screwdriver (one is included with your unit), set the Frequency Select Switches to CC. (for Change, Change).
- 4) Power up the unit briefly – just long enough for the LED's to light up and then turn it off.
- 5) Change the Frequency Select Switches to one of the following settings:
 - To set Lectrosonics 100 Series mode: set switches to 1,1
 - To set Lectrosonics 200 Series mode: set switches to 2,2
 - To set Mode 3: set switches to 3,3 (contact the factory for details)
 - To set Lectrosonics Hybrid mode: set switches to 4,4
 - To set IFB mode: set switches to 5,5 (not available on earlier units)
 - To set Mode 6: set switches to 6,6
- 6) Turn the unit on, wait a couple of seconds and turn it off again.
- 7) Change the Frequency Select Switches to 0,0.
- 8) Turn on the transmitter to complete the operation.

The LEDs will blink to indicate the selected compatibility mode. Immediately after power up, all LEDs will blink together red, then green, followed by the audio level LEDs (-20 and -10) blinking to indicate the mode.

The -20 and -10 LEDs will blink:

- **Once for 100 Series mode**
- **Two times for 200 Series mode**
- **Three times for Mode 3**
- **Four times for Hybrid mode**
- **Five times for IFB mode (if available)**
- **Six times for Mode 6**

At powerup the transmitter will confirm the current compatibility mode with the number of blinks listed here. This setting will remain the same until you reset it with the procedure listed above.

Attaching a Microphone and Adjusting Gain

- 1) Ensure the battery is in good condition.
- 2) Insert the microphone plug into the input jack, aligning the pins; be sure that the connector locks.
- 3) Attach the antenna to the SMA connector on the top of the transmitter.
- 4) Mute the associated receiver's audio output.
- 5) Turn on the transmitter.
- 6) Position the microphone in the location you will use in actual operation. While speaking or singing at the same voice level that will actually be used, observe the Modulation LEDs. Adjust the AUDIO LEVEL control until the -20 dB LED glows green with occasional red flickers and -10 dB glows green.. This will set the gain of your transmitter for signal peaks between +0 dB and +10 dB modulation. (See chart below.)

Signal Level	-20 LED	-10 LED
Less than -20 dB	○ Off	○ Off
-20 dB to -10 dB	● Green	○ Off
-10 dB to +0 dB	● Green	● Green
+0 dB to +10 dB	● Red	● Green (optimum)
Greater than +10 dB	● Red	● Red

- 7) Once the gain has been adjusted, the audio system audio can be turned on to make level adjustments in the main audio system.

NOTE: The transmitter Audio Level Control should not be used to control the volume of your sound system or recorder levels. This gain adjustment matches the transmitter gain with the user's voice level and microphone positioning. Adjust the receiver output level to match the sound system or recorder.

Operating Notes

If the audio level is too high — both LEDs will blink red frequently or glow a steady red. This condition may reduce the dynamic range of the audio signal.

If the audio level is too low — neither LED will glow, or only the -20 LED will glow green. This condition may cause hiss and noise in the audio.

Different voices will usually require different settings of the AUDIO LEVEL control, so check this adjustment as each new person uses the system. If several different people will be using the transmitter and there is not time to make the adjustment for each individual, adjust it for the loudest voice.

Adjusting the Transmitter Frequency

If you are experiencing interference from another signal on your frequency, you will need to change the operating frequency of your system.

If you are using a receiver with a frequency scan function, find a clear frequency with the receiver, then set the transmitter to match.

Note: Leave the transmitter turned off while you search for a clear frequency.

The left switch changes the operating frequency by 1.6 MHz per step and the right switch changes it 100 kHz per step. Start by changing the operating frequency in 100 kHz increments to find a clear channel. If it is not possible to find a clear channel using the 100 kHz switch, return it to its original position and change the 1.6 MHz switch by one click then try the 100 kHz switch again.

To gain access to these switches, slide the access door sideways with a fingernail.

With Lectrosonics Digital Hybrid receivers, a front panel LCD character display will indicate the correct transmitter switch settings.



5-Pin Input Jack Wiring

The wiring diagrams included in this section represent the basic wiring necessary for the most common types of microphones and other audio inputs. Some microphones may require extra jumpers or a slight variation on the diagrams shown.

It is virtually impossible to keep completely up to date on changes that other manufacturers make to their products, thus you may encounter a microphone that differs from these instructions. If this occurs please call our toll-free number listed under Service and Repair in this manual or visit our web site at: www.lectrosonics.com



The Audio Input Jack for the UM400a is wired as shown below:

- PIN 1** Shield (ground) for positive biased electret lavaliere microphones. Shield (ground) for dynamic microphones and line level inputs.
- PIN 2** Bias voltage source for positive biased electret lavaliere microphones.
- PIN 3** Low impedance microphone level input for dynamic microphones. Also accepts hand-held electret microphones provided the microphone has its own built-in battery.
- PIN 4** Bias voltage selector for Pin 3. Pin 3 voltage (0, 2 or 4 volts) depends on Pin 4 connection.
 - Pin 4 tied to Pin 1: 0 V
 - Pin 4 Open: 2 V
 - Pin 4 to Pin 2: 4 V
- PIN 5** High impedance, line level input for tape decks, mixer outputs, musical instruments, etc.

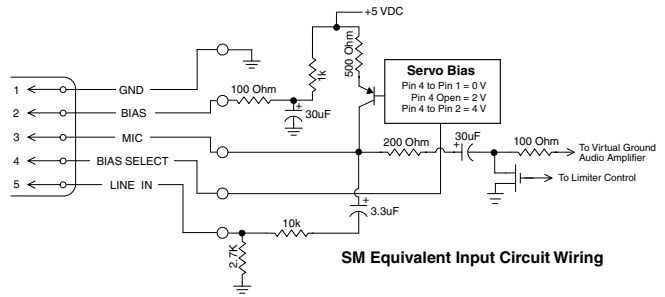

Microphone Cable Termination for Non-Lectrosonics Microphones

TA5F Connector Assembly

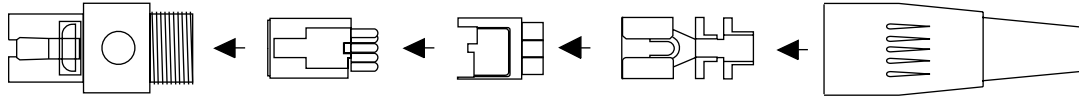

Mic Cord Stripping Instructions

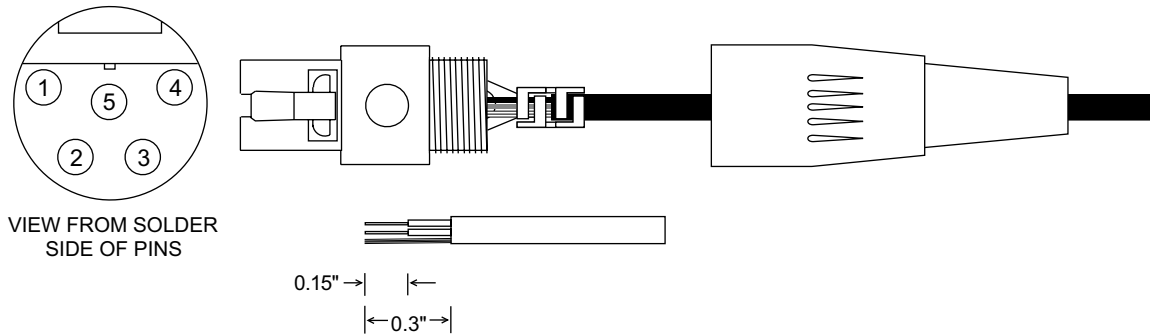

Crimping to Shield and Insulation

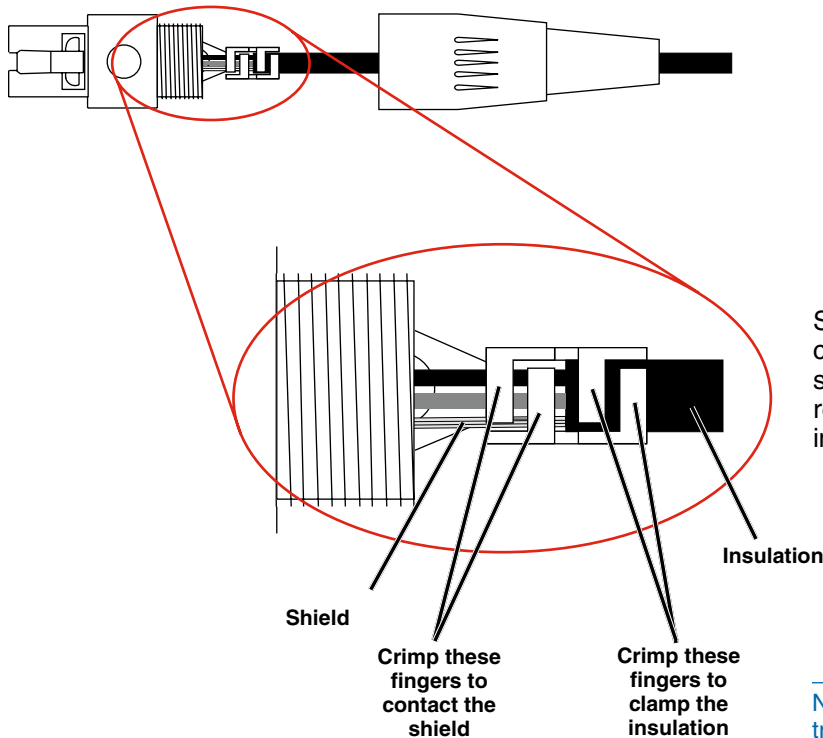

Strip and position the cable so that the clamp can be crimped to contact both the mic cable shield and the insulation. The shield contact reduces noise with some microphones and the insulation clamp increases ruggedness.

NOTE: This termination is intended for UHF transmitters only. VHF transmitters with 5-pin jacks require a different termination. Lectrosonics lavalier microphones are terminated for compatibility with VHF and UHF transmitters, which is different than what is shown here.

Microphone RF Bypassing

When used on a wireless transmitter, the microphone element is in the proximity of the RF coming from the transmitter. The nature of electret microphones makes them sensitive to RF, which can cause problems with microphone/transmitter compatibility. If the electret microphone is not designed properly for use with wireless transmitters, it may be necessary to install a chip capacitor in the mic capsule or connector to block the RF from entering the electret capsule.

Some mics require RF protection to keep the radio signal from affecting the capsule, even though the transmitter input circuitry is already RF bypassed (see schematic diagram).

If the mic is wired as directed, and you are having difficulty with squealing, high noise, or poor frequency response, RF entering the capsule may be the cause.

The best RF protection is accomplished by installing RF bypass capacitors at the mic capsule. If this is not possible, or if you are still having problems, capacitors can be installed on the mic pins inside the TA5F connector housing.

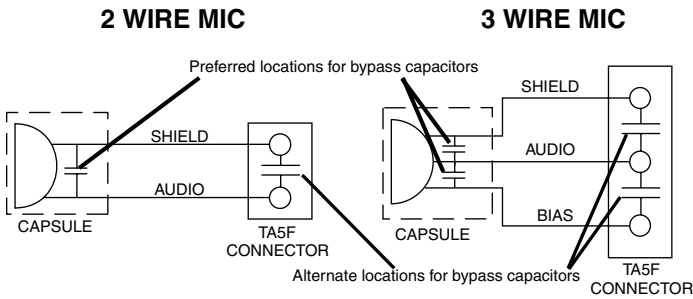

Install the capacitors as follows. Use 330 pF capacitors. Capacitors are available from Lectrosonics. Please specify the part number for the desired lead style.

- Leaded capacitors: P/N 15117
- Leadless capacitors: P/N SCC330P

NOTE: All Lectrosonics lavalier mics are already bypassed and do not need any additional capacitors installed for proper operation.

Line Level Signals

The normal hookup for line level signals is: Signal Hot to pin 5, Signal Gnd to pin 1 and pin 4 jumped to pin 1. This allows signal levels up to 3V RMS to be applied without limiting.

If more headroom is needed, insert a 20 k resistor in series with pin 5. Put this resistor inside the TA5F connector to minimize noise pickup.

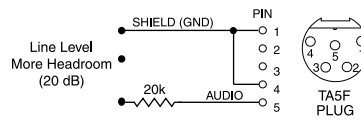
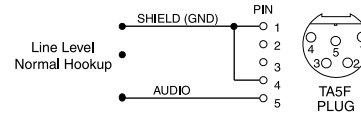

Wiring Hookups for Different Sources

In addition to the microphone and line level wiring hookups illustrated below, Lectrosonics makes a number of cables and adapters for other situations such as connecting musical instruments (guitars, bass guitars, etc.) to the transmitter. Visit www.lectrosonics.com and click on Accessories, or download the master catalog.

A lot of information regarding microphone wiring is also available in the FAQ section of the web site at:

<http://www.lectrosonics.com/faq.htm>

Follow the instructions to search by model number or other search options.

Compatible Wiring for Both Servo Bias Inputs and Earlier Transmitters:

2 VOLT POSITIVE BIAS 2-WIRE ELECTRET

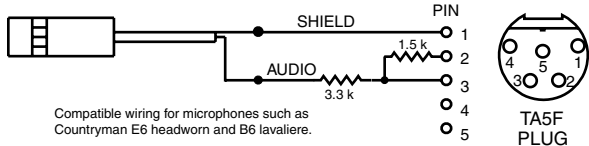

4 VOLT POSITIVE BIAS 2-WIRE ELECTRET

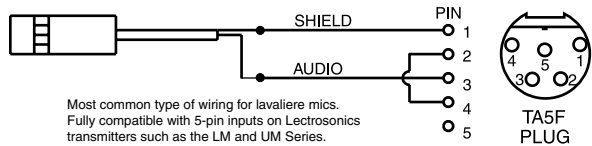

DPA MICROPHONES (Danish Pro Audio miniature models)

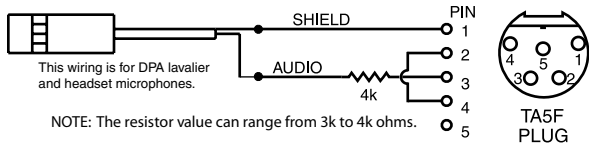

UNBALANCED LINE LEVEL SIGNALS

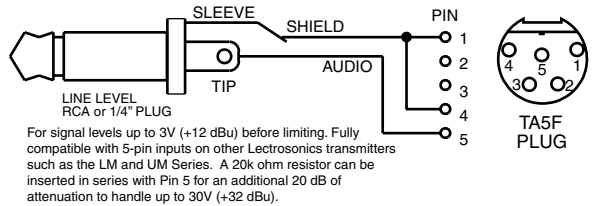

2 VOLT NEGATIVE BIAS 2-WIRE ELECTRET

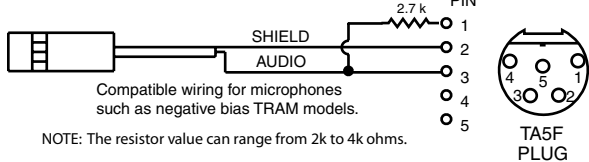

BALANCED AND FLOATING LINE LEVEL SIGNALS

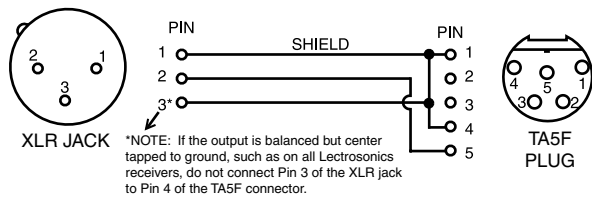

4 VOLT POSITIVE BIAS 3-WIRE ELECTRET WITH EXTERNAL RESISTOR

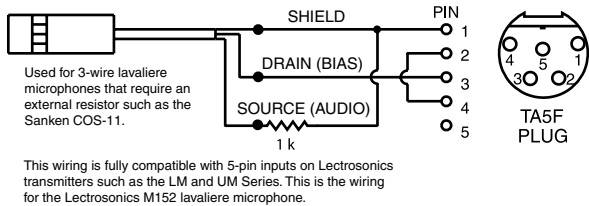

LO-Z MICROPHONE LEVEL SIGNALS

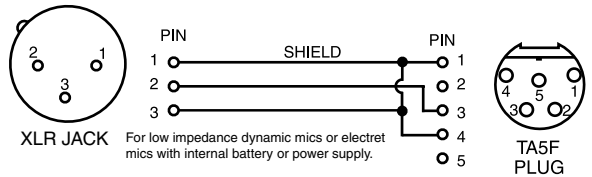

Simple Wiring for Servo Bias Inputs Only:

2 VOLT POSITIVE BIAS 2-WIRE ELECTRET

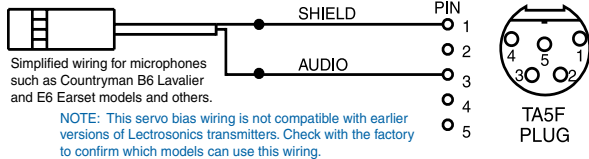

4 VOLT POSITIVE BIAS 3-WIRE ELECTRET

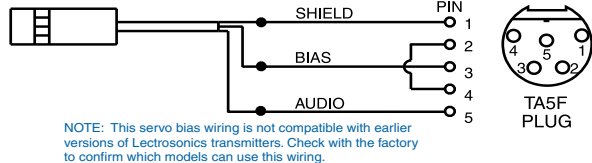

2 VOLT NEGATIVE BIAS 2-WIRE ELECTRET

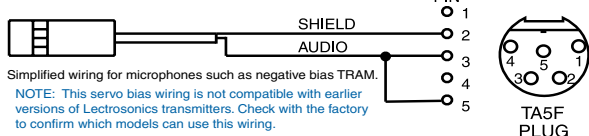

Replacement Parts and Accessories

Item	Model/Part Number
Replacement wire belt clip	Lectrosonics #BCWire
Replacement whip antenna	Lectrosonics AMM (xx) - specify frequency block (xx)

UHF Transmitter Antenna Specifications

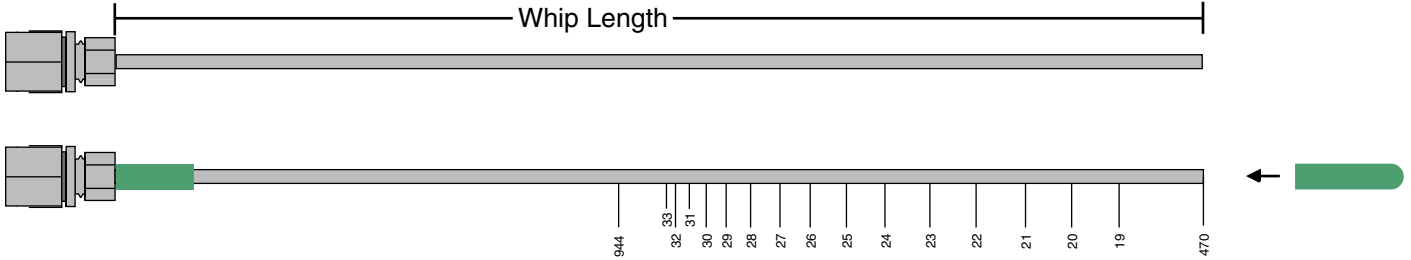

Note: Check the scale of your printout. This line should be 6.00 inches long (152.4 mm).

Lectrosonics AMM Series UHF transmitter antennas follow the color code specifications in the chart below to identify operating frequency block range. (The frequency block range is engraved on the outside housing for each individual transmitter.) If a situation exists whereby the antenna is defective and the antenna cap is missing, refer to the following chart to determine the correct replacement antenna.

BLOCK	FREQUENCY RANGE	CAP COLOR	ANTENNA WHIP LENGTH
470	470.100 - 495.600	Black	5.48"
19	486.400 - 511.900	Black	5.20"
20	512.000 - 537.500	Black	4.95"
21	537.600 - 563.100	Brown	4.74"
22	563.200 - 588.700	Red	4.48"
23	588.800 - 614.300	Orange	4.24"
24	614.400 - 639.900	Yellow	4.01"
25	640.000 - 665.500	Green	3.81"
26	665.600 - 691.100	Blue	3.62"
27	691.200 - 716.700	Violet (Pink)	3.46"
28	716.800 - 742.300	Grey	3.31"
29	742.400 - 767.900	White	3.18"
944	944.100 - 951.900	Black-w/Label	2.62"

Troubleshooting

Before going through the following chart, be sure that you have a good battery in the transmitter. It is important that you follow these steps in the sequence listed.

Symptom	Possible Cause
TRANSMITTER BATTERY LED OFF	<ol style="list-style-type: none"> 1) Battery is inserted backwards. 2) Battery is dead.
NO TRANSMITTER MODULATION LEDS	<ol style="list-style-type: none"> 1) Gain control turned all the way down. 2) Battery is in backwards. Check power LED. 3) Mic capsule is damaged or malfunctioning. 4) Mic cable damaged or mis-wired.
RECEIVER RF LAMP OFF	<ol style="list-style-type: none"> 1) Transmitter not turned on. 2) Transmitter battery is dead. 3) Receiver antenna missing or improperly positioned. 4) Transmitter and receiver not on same frequency. Check switches/display on transmitter and receiver. 5) Operating range is too great. 6) Transmitter antenna not connected
NO SOUND (OR LOW SOUND LEVEL), RECEIVER INDICATES PROPER AUDIO MODULATION	<ol style="list-style-type: none"> 1) Receiver output level set too low. 2) Receiver output is disconnected; cable is defective or mis-wired. 3) Transmitter is not set to same frequency as receiver. Check that frequency select switches on receiver and transmitter match. 4) Sound system or recorder input is turned down.
DISTORTED SOUND	<ol style="list-style-type: none"> 1) Transmitter gain (audio level) is far too high. Check mod level lamps on transmitter and receiver as it is being used. (Refer to Operating Instructions - Adjusting Gain) 2) Receiver output may be mismatched with the sound system or recorder input. Adjust output level on receiver to the correct level for the recorder, mixer or sound system. 3) Excessive wind noise or breath "pops.. Reposition microphone and/or use a larger windscreen.
HISS AND NOISE -- AUDIBLE DROPOUTS	<ol style="list-style-type: none"> 1) Transmitter gain (audio level) far too low. 2) Receiver antenna missing or obstructed. 3) Transmitter antenna missing or folded against housing. 4) Operating range too great.
EXCESSIVE FEEDBACK	<ol style="list-style-type: none"> 1) Transmitter gain (audio level) too high. Check gain adjustment and/or reduce receiver output level. 2) Transmitter too close to speaker system. 3) Mic is too far from user's mouth.

Specifications and Features

Operating frequencies:	Block 470: 470.100 - 495.600 Block 19: 486.400 - 511.900 Block 20: 512.000 - 537.500 Block 21: 537.600 - 563.100 Block 22: 563.200 - 588.700 Block 23: 588.800 - 607.90. an. 614.100 - 614.300 Block 24: 614.400 - 639.900 Block 25: 640.000 - 665.500 Block 26: 665.600 - 691.100 Block 27: 691.200 - 716.700 (export only) Block 28: 716.800 - 742.300 (export only) Block 29: 742.400 - 767.900 (export only) Block 944: 944.100 - 951.900
Frequency selection:	256 frequencies in 100kHz steps
RF Power output:	100 mW (nominal)
Pilot tone:	25 to 32 kHz frequency; 5kHz deviation
Frequency stability:	± 0.002%
Deviation:	± 75 kHz (max)
Spurious radiation:	90 dB below carrier
Equivalent input noise:	-120 dBV, A-weighted
Input level:	Nominal 2 mV to 300 mV, before limiting. Greater than 1V maximum, with limiting.
Input impedance:	
Dynamic mic:	300 Ohms
Electret lavaliere:	Input is virtual ground with servo adjusted constant current bias
Line level:	2.7 k Ohms
Input compressor:	Dual envelope compressor, >30 dB range
Gain control range:	43 dB; semi-log rotary control
Modulation indicators:	Dual bicolor LEDs indicate modulation. of -20, -10, 0, +10 dB referenced to full modulation.
Low frequency roll-off:	-18 dB/octave; 35Hz to 150Hz
Audio frequency response (overall system):	35 Hz to 20 kHz, +/-1 dB (<i>The low frequency roll-off is adjustable - see graph</i>)

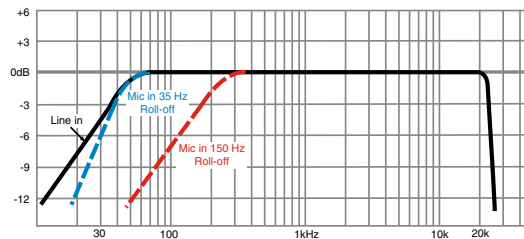

Controls:	2 position "OFF-ON" slide switch for noiseless turn on/turn off operation. Front panel knob adjusts audio gain. Recessed control on side panel adjusts low frequency rolloff. Rotary switches on side panel adjust transmitter frequency.
Audio Input Jack:	Switchcraft 5 pin locking (TA5F)
Antenna:	Detachable, flexible wire supplied. 50 Ohm port allows connection to test equipment.
Power Consumption:	80mA
Battery:	Precision compartment auto-adjusts to accept any known alkaline 9 Volt battery.
Battery Life:	5 hours (alkaline); 10 hours (lithium)
Operating Temperature:	-20 to +140 degrees F
Weight:	6.3 ozs. including battery
Dimensions:	3.1 x 2.4 x .75 inches

Emission Designator: 180KF3E

Specifications subject to change without notice.

The FCC requires that the following statement be included in this manual:

This device complies with FCC radiation exposure limits as set forth for an uncontrolled environment. This device should be installed and operated so that its antenna(s) are not co-located or operating in conjunction with any other antenna or transmitter.

Service and Repair

If your system malfunctions, you should attempt to correct or isolate the trouble before concluding that the equipment needs repair. Make sure you have followed the setup procedure and operating instructions. Check the interconnecting cables and then go through the **Troubleshooting** section in this manual.

We strongly recommend that you **do not** try to repair the equipment yourself and **do not** have the local repair shop attempt anything other than the simplest repair. If the repair is more complicated than a broken wire or loose connection, send the unit to the factory for repair and service. Don't attempt to adjust any controls inside the units. Once set at the factory, the various controls and trimmers do not drift with age or vibration and never require readjustment. **There are no adjustments inside that will make a malfunctioning unit start working.**

Lectrosonics' Service Department is equipped and staffed to quickly repair your equipment. In warranty repairs are made at no charge in accordance with the terms of the warranty. Out-of-warranty repairs are charged at a modest flat rate plus parts and shipping. Since it takes almost as much time and effort to determine what is wrong as it does to make the repair, there is a charge for an exact quotation. We will be happy to quote approximate charges by phone for out-of-warranty repairs.

Returning Units for Repair

For timely service, please follow the steps below:

- A. DO NOT return equipment to the factory for repair without first contacting us by email or by phone. We need to know the nature of the problem, the model number and the serial number of the equipment. We also need a phone number where you can be reached 8 A.M. to 4 P.M. (U.S. Mountain Standard Time).
- B. After receiving your request, we will issue you a return authorization number (R.A.). This number will help speed your repair through our receiving and repair departments. The return authorization number must be clearly shown on the **outside** of the shipping container.
- C. Pack the equipment carefully and ship to us, shipping costs prepaid. If necessary, we can provide you with the proper packing materials. UPS is usually the best way to ship the units. Heavy units should be "double-boxed" for safe transport.
- D. We also strongly recommend that you insure the equipment, since we cannot be responsible for loss of or damage to equipment that you ship. Of course, we insure the equipment when we ship it back to you.

Lectrosonics USA:

Mailing address:
Lectrosonics, Inc.
PO Box 15900
Rio Rancho, NM 87174
USA

Shipping address:
Lectrosonics, Inc.
581 Laser Rd.
Rio Rancho, N. 87124
USA

Telephone:
(505) 892-4501
(800) 821-1121 Toll-free
(505) 892-6243 Fax

Web:
www.lectrosonics.com

E-mail:
sales@lectrosonics.com

Lectrosonics Canada:

Mailing Address:
720 Spadina Avenue,
Suite 600
Toronto, Ontario M5S 2T9

Telephone:
(416) 596-2202
(877) 753-2876 Toll-free
(877-7LECTRO)
(416) 596-6648 Fax

E-mail:
Sales: colinb@lectrosonics.com
Service: joeb@lectrosonics.com

LIMITED ONE YEAR WARRANTY

The equipment is warranted for one year from date of purchase against defects in materials or workmanship provided it was purchased from an authorized dealer. This warranty does not cover equipment which has been abused or damaged by careless handling or shipping. This warranty does not apply to used or demonstrator equipment.

Should any defect develop, Lectrosonics, Inc. will, at our option, repair or replace any defective parts without charge for either parts or labor. If Lectrosonics, Inc. cannot correct the defect in your equipment, it will be replaced at no charge with a similar new item. Lectrosonics, Inc. will pay for the cost of returning your equipment to you.

This warranty applies only to items returned to Lectrosonics, Inc. or an authorized dealer, shipping costs prepaid, within one year from the date of purchase.

This Limited Warranty is governed by the laws of the State of New Mexico. It states the entire liability of Lectrosonics Inc. and the entire remedy of the purchaser for any breach of warranty as outlined above. NEITHER LECTROSONICS, INC. NOR ANYONE INVOLVED IN THE PRODUCTION OR DELIVERY OF THE EQUIPMENT SHALL BE LIABLE FOR ANY INDIRECT, SPECIAL, PUNITIVE, CONSEQUENTIAL, OR INCIDENTAL DAMAGES ARISING OUT OF THE USE OR INABILITY TO USE THIS EQUIPMENT EVEN IF LECTROSONICS, INC. HAS BEEN ADVISED OF THE POSSIBILITY OF SUCH DAMAGES. IN NO EVENT SHALL THE LIABILITY OF LECTROSONICS, INC. EXCEED THE PURCHASE PRICE OF ANY DEFECTIVE EQUIPMENT.

This warranty gives you specific legal rights. You may have additional legal rights which vary from state to state.



581 Laser Road NE • Rio Rancho, NM 87124 USA • www.lectrosonics.com
+1(505) 892-4501 • fax +1(505) 892-6243 • (800) 821-1121 US and Canada • sales@lectrosonics.com

UM400aman.indd
19 June 2015