

Octopack™

Portable Multicoupler



Power and RF Distribution for SR Series Compact Receivers

CE 1313 ⓘ UK
CA

Fill in for your records:

Serial Number:

Purchase Date:

FCC Compliance

This device complies with Part 15 of the FCC Rules. Operation is subject to the following two conditions: (1) This device may not cause harmful interference, and (2) this device must accept any interference received, including interference that may cause undesired operation.

The Octopack has been tested and found to comply with the limits for a Class B digital device, pursuant to Part 15 of the FCC Rules. These limits are designed to provide reasonable protection against harmful interference in a residential installation. However, there is no guarantee that interference will not occur in a particular installation. This equipment generates, uses and can radiate radio frequency energy and, if not installed and used in accordance with the instructions, may cause interference to radio receivers. Changes or modifications to this equipment not expressly approved by Lectrosonics, Inc. could void the user's authority to operate it.

If this equipment does cause harmful interference to radio or television reception, which can be determined by turning the equipment off and on, the user is encouraged to try to correct the interference by one or more of the following measures:

- Reorient or relocate the receiving antenna
- Increase the separation between this equipment and receiver
- Connect this equipment into an outlet on a circuit different from that which the receiver is connected
- Consult the dealer or an experienced radio/TV technician for help

Table of Contents

- General Technical Description4
- Control Panel5
- Battery Panel6
- Side Panel6
- Receiver Installation.....7
- Receiver Removal.....8
- Antenna Power Jumpers9
- Antenna Bandwidth and Requirements..... 10
- Antenna/Block Reference Chart 11
- Antenna Cutting Template 11
- Optional Accessories 12
- Replacement Parts & Accessories 13
- Troubleshooting..... 14
- Specifications 14
- Service and Repair 15
- Returning Units for Repair..... 15

General Technical Description

To address an increasing demand for more wireless channels in location production, the Octopack combines up to four SR Series compact receivers into a lightweight, rugged assembly with self-contained power supply, power distribution and antenna signal distribution. This versatile production tool provides up to eight audio channels in a tiny package ready to work in applications from production cart to a portable mixing bag.

High quality antenna distribution requires the use of ultra quiet RF amps plus isolated and optimally matched signal paths through the circuitry to ensure equal performance from all connected receivers. In addition, the amplifiers used must be high overload types to avoid generating IM (intermodulation) within the multicoupler itself. Octopack meets these requirements for RF performance.

Receivers can be installed in any of the four slots, or a slot can be left empty with no need to terminate the RF coaxial connections. The receivers interface with the Octopack circuit board via the 25-pin Unislot adapter, so in many cases, the receivers can be moved from the Octopack to a camera without having to change the adapter.

Antenna inputs are standard 50 ohm BNC jacks. DC power on the jacks can be switched on for use with Lectrosonics UFM230 RF amplifiers or the ALP650 powered antenna for long coaxial cable runs. An LED next to the recessed switch indicates the power status.

The front panel is designed for the SR5P receiver which provides audio outputs on the front panel of the receiver in addition to the outputs on the Octopack. The second set of audio outputs can be used for a redundant feed to a recorder in addition to the main outputs that would typically feed wireless transmitters in a bag system, or a mixer on a sound cart.

The Octopack housing is constructed of machined aluminum with a reinforced rear/bottom panel to protect the batteries and power jack. The front panel includes two rugged handles that protect the connectors, receiver front panels and antenna jacks.

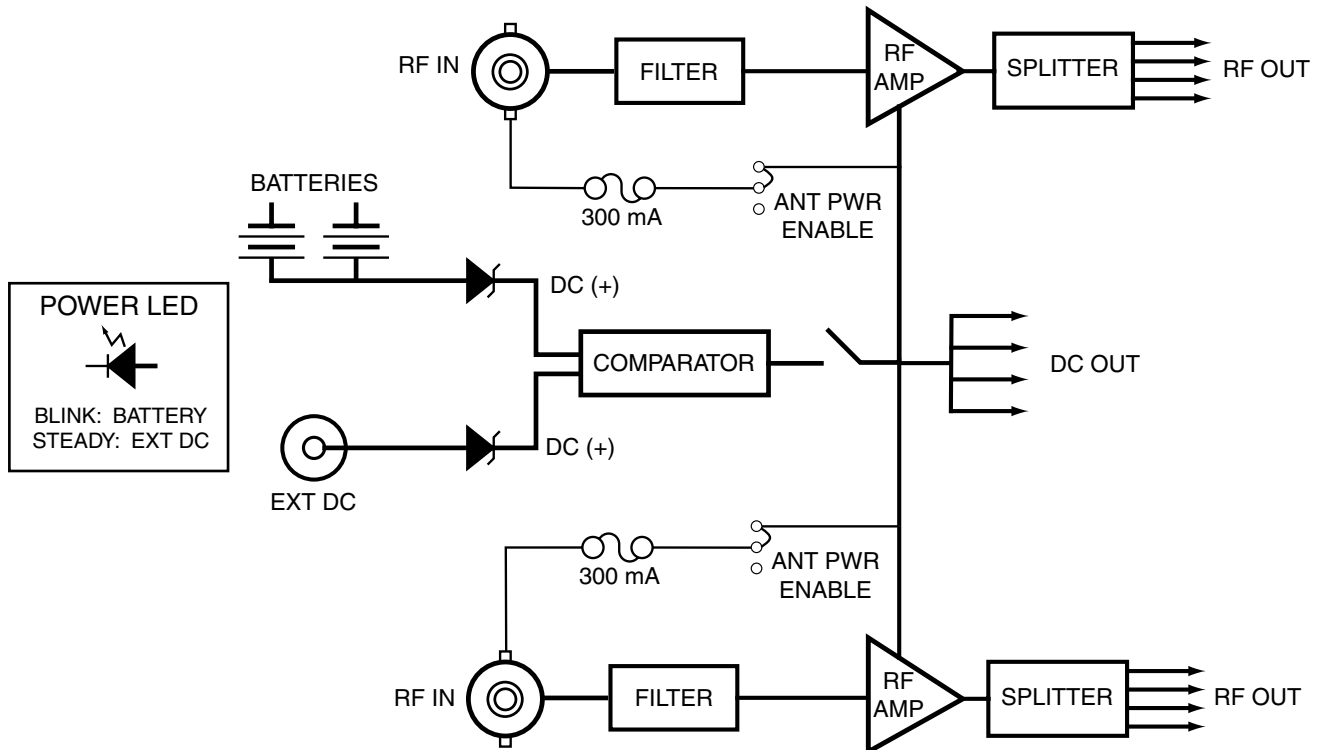

Control Panel

RF Signal Distribution

Each antenna input is routed through a high quality RF splitter to coaxial leads on the control panel. Gold plated right angle connectors mate to the SMA jacks on SRa Series receivers.

Power Indication

The power switch locks in position to prevent accidental turn off. When power is engaged, the LED next to the switch illuminates to indicate the source, remaining steady when external power is selected and blinking slowly when the batteries are providing power.

Antenna Power

A recessed switch on the left side of the control panel enables and disables DC power passed from the power supply to the BNC antenna connectors. This provides powering of remote RF amplifiers through the attached coaxial cable. The LED glows red when power is enabled.

Receiver Versions

SR and SR5P receivers can be used together provided the frequencies fall within the bandwidth of the antenna multicoupler. The earlier versions of the receivers with attached antennas cannot be connected to the multicoupler antenna feeds.



Battery Panel

The passband of the multicoupler is marked on the label on the housing cover next to the battery panel.

IMPORTANT - The frequency of the receivers installed in the unit must fall within the passband indicated on the label. Serious signal loss can result if the receiver frequencies are outside the Octopack RF passband.

External DC Power

Any type of external power supply can be used to operate the Octopack the supply if it has the correct connector and it can provide the necessary current. The required polarity, voltage range and maximum current consumption are engraved next to the power jack.

Battery Power

The rear/bottom panel provides a locking power jack and mounting for two SR9VBP 9V battery adapters.

Automatic Backup Power

When batteries and external DC are both connected, power is drawn from the source with the highest voltage. In most cases, the external DC source will provide a higher voltage than the batteries, so the batteries serve to provide an automatic backup function. If the external source fails, the batteries will immediately take over and the power LED will blink slowly. For reliability, the switching is handled by circuitry rather than a mechanical switch or relay.

Side Panel

Eight balanced outputs are provided on the side panel of the multicoupler. When the receivers operate in a 2-channel mode, each jack provides a separate audio channel. In the ratio diversity mode, the receivers are paired, so adjacent output jacks deliver the same audio channel.

The connectors are standard TA3M types, with the same pinout numbering as 3-pin XLR connectors.



External DC Power Jack
4-pin Hirose

Battery Retainer Tabs - Press to Release

External DC Power Jack
Coaxial Locking Type

Receiver Installation

First install the SRUNI rear panel adapter.



The mating 25-pin connector inside each slot on the Octopack provides power and audio connections.

RF leads are connected in a “criss-cross” pattern as shown below to avoid sharp bends in the cables. The leads are marked on the control panel as **B** on the left and **A** on the right side of each slot. The antenna inputs on the receivers are the opposite, with **A** on the left and **B** on the right. The right angle connectors help to maintain a low profile and visibility of the LCDs on the receivers.

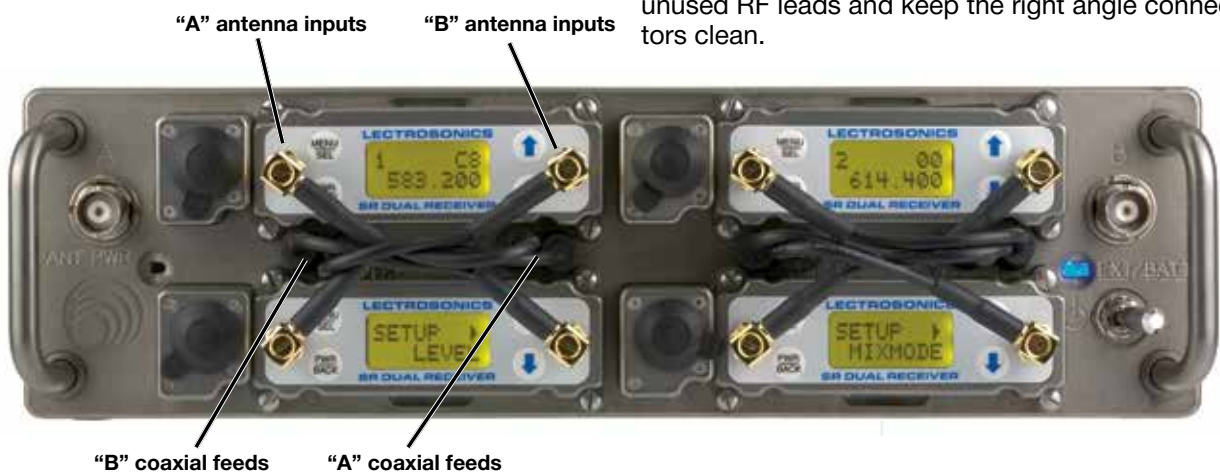

Gently insert the receivers into the slots. A guide around each internal connector centers the housing to align the connector pins.



Plastic inserts are provided to cover empty slots. Sockets in the insert are sized to store loose antenna leads.



Sockets in the slot covers are provided to store unused RF leads and keep the right angle connectors clean.

WARNING: DO NOT use Hirose 4-pin DC connector on the Octopack when mounting DSR4 receivers.

Receiver Removal

Disconnect all four mounting screws on each receiver from the Octopack panel



A handy tool, constructed of Delrin, is provided to aid in removing the receivers and to loosen overly tightened coaxial connectors.



The supplied tool is stored in a clip on the battery

It is difficult to remove the receivers by hand due to the friction in the 25-pin connector in the slot and the difficulty of gripping the receiver housing. The flat end of the tool is used to remove the receivers by prying the housing upward in the notch next to the slot.

DO NOT remove the receivers by pulling on the antennas since the antennas and/or connectors can be damaged.



Pry the receiver housing upward in the notch to release the 25-pin connector

Normally the hex nuts on the coaxial RF leads are secured and removed by hand. The tool is provided if the nuts cannot be removed by hand.

DO NOT overtighten the nuts with the wrench.



The open end wrench is used to loosen coaxial connector nuts that have been overtightened.

Antenna Power Jumpers

Power for Lectrosonics remote RF amplifiers is provided by DC voltage from the power supply passed directly to the BNC jacks on the control panel. An illuminated switch on the left side of the control panel enables and disables the power. A 300 mA polyfuse protects against excessive current in each BNC output.



Antenna power switch glows red when DC power is enabled.

NOTE: The control panel LED will continue to indicate that antenna power is turned on even if one or both jumpers is set to disable it.

Antenna power can be disabled at each of the BNC connectors with jumpers on the internal circuit board. Remove the cover panel to access the jumpers.

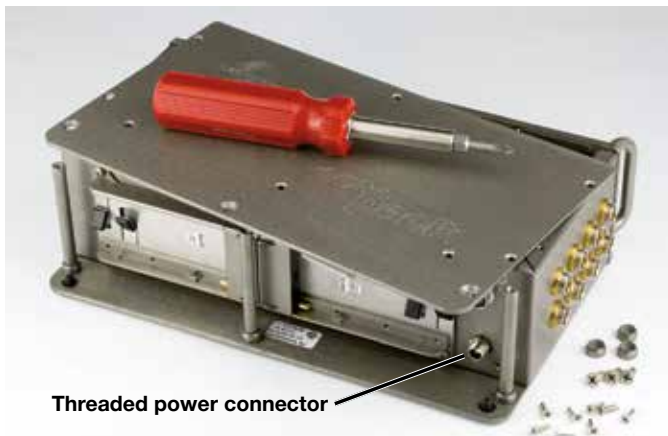

Threaded power connector

Remove the eight smaller screws from the housing and the three larger screws from the support posts. Jumpers are located near the corners of the board.

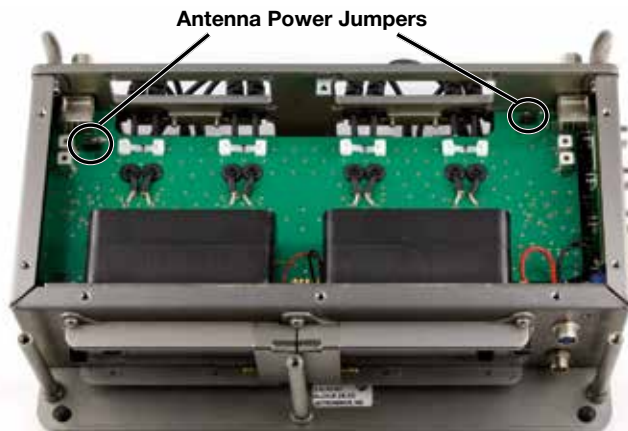

Antenna Power Jumpers

Install the jumpers towards the center of the circuit board to enable the antenna power, and towards the outside of the circuit board to disable it.

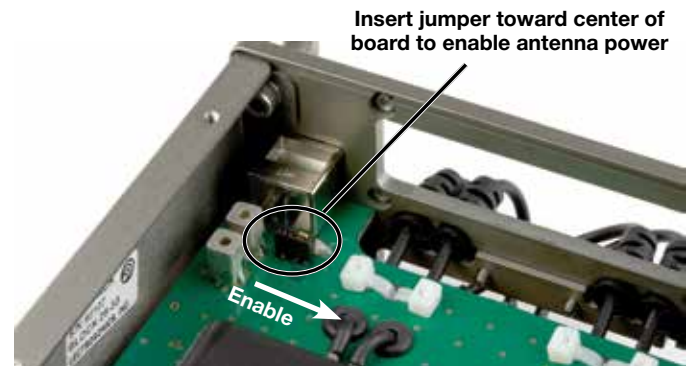

Insert jumper toward center of board to enable antenna power

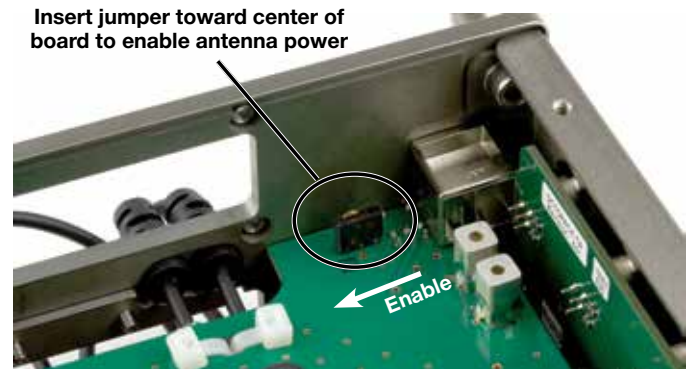

Insert jumper toward center of board to enable antenna power

NOTE: No damage will occur if a standard antenna is connected while antenna power is enabled.

Place the ferrules on top of the support posts before attaching the cover. Be careful not to overtighten the screws.

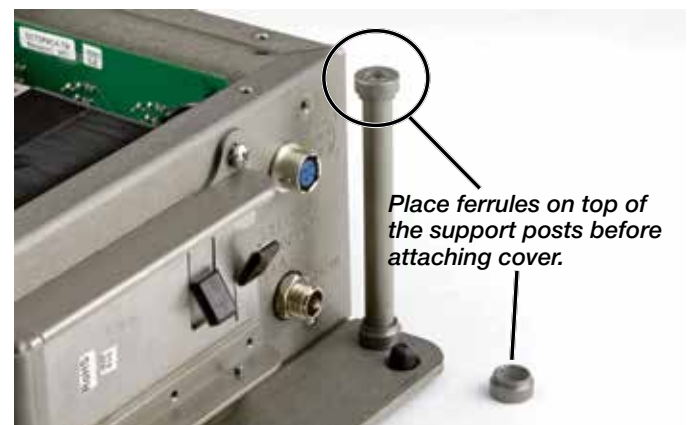

Place ferrules on top of the support posts before attaching cover.

NOTE: When using any amplifier other than Lectrosonics models, make certain that the DC voltage and power consumption are within an acceptable range.

Antenna Bandwidth and Requirements

The design of Lectrosonics wideband multicouplers helps deal with a changing RF spectrum, however, it also introduces the requirement for specific or more advanced antennas to provide maximum operating range. Simple whip antennas cut to a single frequency block are inexpensive and effective at covering a 50 to 75 MHz band, but will not provide adequate coverage for the entire range of a wideband antenna multicoupler. Following are the antenna options available from Lectrosonics.

| Model | Type | Bandwidth MHz |
|------------------------|----------------|--------------------|
| A500RA(xx) and A8U(xx) | Whip | 30 to 35 (typical) |
| ACOAXBNC(xx) | Coaxial | 30 to 35 (typical) |
| SNA600 | Tunable dipole | 100 |
| ALP500 | Log-periodic | 450 - 850 |
| ALP620 | Log-periodic | 450 - 850 |
| ALP650 (w/ amp) | Log-periodic | 537 - 767 |
| ALP650L (w/ amp) | Log-periodic | 470 - 692 |

In the table, (xx) with the whip and coaxial antenna model numbers refers to the specific frequency block that the antenna is precut to use. The SNA600 model is tunable to move the center frequency of its 100 MHz bandwidth up and down from 550 to 800 MHz.

The greater the mismatch of frequencies between the antenna and the receiver, the weaker the signal will be, and the shorter the maximum operating range of the wireless system. Experimentation and checking the range before the production starts is always a good idea, and is mandatory if the frequencies of the antenna and receiver do not match exactly. On many production sets, the short operating range that is needed may allow the use of a slightly mismatched whip antenna.

In general, using a whip antenna one block above or below the receiver range will provide adequate range, often with no noticeable difference from the correct antenna.

Use the RF level meter on the receiver to check the received signal strength. Keep in mind that the signal level varies wildly as the system operates, so be sure to conduct a walk test through the area to identify locations where the signal drops to very low levels.

There are also many antennas made by other companies, which are easily found by searching for web sites. Use search terms like “log-periodic,” “directional,” “broadband,” “discone,” etc.

<http://www.ramseyelectronics.com/downloads/manuals/DA25.pdf>



A500RA
(precut to block)



ACOAXBNC
(precut to block)

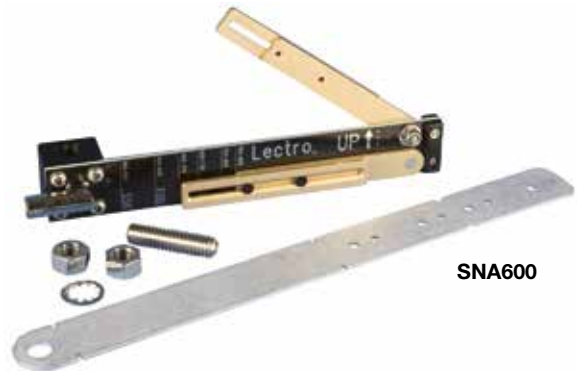

SNA600



ALP500

ALP620

ALP650

Antenna/Block Reference Chart

The A8U whip UHF whip antenna is factory cut to a specific frequency block as shown in the table below. A colored cap and label are used on blocks 21 through 29, and a black cap and label are used on the other blocks to denote the frequency range of each model.

The A8UKIT is also available to construct an antenna as needed. The chart is used to cut the length correctly and for identifying the frequency of an antenna that is not marked.

The lengths shown are specifically for the A8U whip antenna with a BNC connector, as determined by measurements with a network analyzer. The optimal length of the element in other designs will likely be different than those shown in this table, but since the bandwidth is typically wider than the specified block, the exact length is not critical for useful performance.

| BLOCK | FREQUENCY RANGE | CAP COLOR | ANTENNA WHIP LENGTH |
|-------|-------------------|----------------|---------------------|
| 470 | 470.100 - 495.600 | Black w/ Label | 5.48" |
| 19 | 486.400 - 511.900 | Black w/ Label | 5.20" |
| 20 | 512.000 - 537.500 | Black w/ Label | 4.95" |
| 21 | 537.600 - 563.100 | Brown | 4.74" |
| 22 | 563.200 - 588.700 | Red | 4.48" |
| 23 | 588.800 - 614.300 | Orange | 4.24" |
| 24 | 614.400 - 639.900 | Yellow | 4.01" |
| 25 | 640.000 - 665.500 | Green | 3.81" |
| 26 | 665.600 - 691.100 | Blue | 3.62" |
| 27 | 691.200 - 716.700 | Violet (Pink) | 3.46" |
| 28 | 716.800 - 742.300 | Grey | 3.31" |
| 29 | 742.400 - 767.900 | White | 3.18" |
| 30 | 768.000 - 793.500 | Black w/ Label | 3.08" |
| 31 | 793.600 - 819.100 | Black w/ Label | 2.99" |
| 32 | 819.200 - 844.700 | Black w/ Label | 2.92" |
| 33 | 844.800 - 861.900 | Black w/ Label | 2.87" |
| 779 | 779.125 - 809.750 | Black w/ Label | 3.00" |

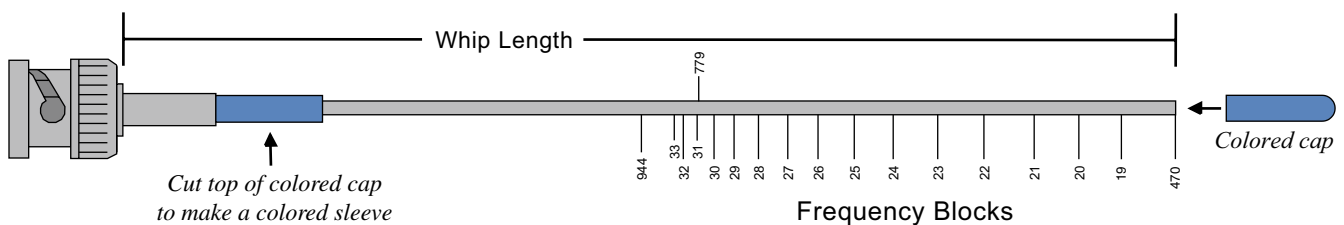

Note: This line should be 6.00" long.

Optional Accessories

Coaxial Cables

A variety of low loss coaxial cables are available to avoid signal loss through longer runs between antenna and receiver. Lengths include 2, 15, 25, 50 and 100 foot lengths. The longer cables are constructed of Belden 9913F with special connectors that terminate directly to BNC jacks, eliminating the need for adapters that can introduce additional signal loss.



ARG Series Coaxial Cables

Customized RF Distribution and Routing

Customized antenna and RF distribution is easy to configure using the UFM230 amplifier, BIAST power inserter and several RF splitter/combiners. These professional grade components preserve signal quality and suppress noise and intermodulation.



UFM230 Filter/Amp



8-way Splitter/Combiner



BIAST Power Inserter



4-way Splitter/Combiner



PF25 Inline Filter



2-way Splitter/Combiner



BIAST Power Inserter

Replacement Parts & Accessories

P1246 Delrin tool for receiver removal and loosening coaxial antenna leads



P1139 Blank slot cover



21746 Power cable with locking, right angle connector to stripped and tinned; 12 inch length



A8U Kit Whip Antenna with BNC Connector and color coded end caps. Includes cutting template and table for all frequency blocks.



SVP9VBP Battery pack for the Octopack or SR BATTSLD. The pack can be used with alkaline, lithium, or rechargeable 9V batteries. .



Troubleshooting

SYMPTOM

NO POWER LED INDICATION

POSSIBLE CAUSE

- 1) Power switch in the OFF position.
- 2) Batteries low or dead
- 3) External DC source too low or disconnected

NOTE: If the power supply voltage drops too low for normal operation, the LCD on the receivers will display a “Low Battery” warning every few seconds. When the voltage drops to 5.5 volts, the LCD will dim and the audio output level of the receivers will decrease.

SHORT OPERATING RANGE, DROPOUTS

OR WEAK OVERALL RF LEVEL
(RF level with receiver LCD)

- 1) Passbands of Octopack and antennas may be different; (check frequency of transmitter must be inside of both passbands)
- 2) Antenna power switched off when external RF amplifiers are being used
- 3) Antenna power interrupted by polyfuse; current consumption of remote amplifier must be less than 300 mA on each BNC
- 4) Coaxial cable runs too long for the cable type

Specifications

| | |
|-------------------------------|--|
| RF Bandwidth (3 versions): | Low: 470 to 691 MHz Mid: 537 to 768 MHz (export) High: 640 to 862 MHz (export) |
| RF Gain | 0 to 2.0 dB across bandwidth |
| Output Third Order Intercept: | +41 dBm |
| 1 dB Compression: | +22 dBm |
| Antenna Inputs: | Standard 50 ohm BNC jacks |
| Antenna Power: | Voltage is passed through from main power source; 300 mA polyfuse in each BNC output |
| Receiver RF feeds: | 50 ohm right angle SMA jacks |
| External Power Requirement: | 8 to 18 VDC |
| Power Consumption: | 1500 mA max. at 10 VDC (both antenna power supplies on) |
| Dimensions: | H 2.75 in. x W10.00 in. x D 6.50 in. H 70 mm x W254 mm x D 165 mm |
| Weight: Assembly only: | 2 lbs., 9 ozs. (1.16 kg) |
| With 4-SR/5P receivers: | 4 lbs., 6 ozs. (1.98 kg) |

Specifications subject to change without notice

Service and Repair

If your system malfunctions, you should attempt to correct or isolate the trouble before concluding that the equipment needs repair. Make sure you have followed the setup procedure and operating instructions. Check the interconnecting cables and then go through the **Troubleshooting** section in this manual.

We strongly recommend that you **do not** try to repair the equipment yourself and **do not** have the local repair shop attempt anything other than the simplest repair. If the repair is more complicated than a broken wire or loose connection, send the unit to the factory for repair and service. Don't attempt to adjust any controls inside the units. Once set at the factory, the various controls and trimmers do not drift with age or vibration and never require readjustment. **There are no adjustments inside that will make a malfunctioning unit start working.**

LECTROSONICS' Service Department is equipped and staffed to quickly repair your equipment. In warranty repairs are made at no charge in accordance with the terms of the warranty. Out-of-warranty repairs are charged at a modest flat rate plus parts and shipping. Since it takes almost as much time and effort to determine what is wrong as it does to make the repair, there is a charge for an exact quotation. We will be happy to quote approximate charges by phone for out-of-warranty repairs.

Returning Units for Repair

For timely service, please follow the steps below:

- A.** DO NOT return equipment to the factory for repair without first contacting us by email or by phone. We need to know the nature of the problem, the model number and the serial number of the equipment. We also need a phone number where you can be reached 8 A.M. to 4 P.M. (U.S. Mountain Standard Time).
- B.** After receiving your request, we will issue you a return authorization number (R.A.). This number will help speed your repair through our receiving and repair departments. The return authorization number must be clearly shown on the **outside** of the shipping container.
- C.** Pack the equipment carefully and ship to us, shipping costs prepaid. If necessary, we can provide you with the proper packing materials. UPS is usually the best way to ship the units. Heavy units should be "double-boxed" for safe transport.
- D.** We also strongly recommend that you insure the equipment, since we cannot be responsible for loss of or damage to equipment that you ship. Of course, we insure the equipment when we ship it back to you.

Lectrosonics USA:

Mailing address:
Lectrosonics, Inc.
PO Box 15900
Rio Rancho, NM 87174
USA

Shipping address:
Lectrosonics, Inc.
581 Laser Rd.
Rio Rancho, NM 87124
USA

Telephone:
(505) 892-4501
(800) 821-1121 Toll-free
(505) 892-6243 Fax

Web:
www.lectrosonics.com

E-mail:
sales@lectrosonics.com

Lectrosonics Canada:

Mailing Address:
720 Spadina Avenue,
Suite 600
Toronto, Ontario M5S 2T9

Telephone:
(416) 596-2202
(877) 753-2876 Toll-free
(877-7LECTRO)
(416) 596-6648 Fax

E-mail:
Sales: colinb@lectrosonics.com
Service: joeb@lectrosonics.com

Self-Help Options for Non-Urgent Concerns

Our Facebook groups and weblists are a wealth of knowledge for user questions and information. Refer to:

Lectrosonics General Facebook Group: <https://www.facebook.com/groups/69511015699>

D Squared, Venue 2 and Wireless Designer Group: <https://www.facebook.com/groups/104052953321109>

The Wire Lists: <https://lectrosonics.com/the-wire-lists.html>

LIMITED ONE YEAR WARRANTY

The equipment is warranted for one year from date of purchase against defects in materials or workmanship provided it was purchased from an authorized dealer. This warranty does not cover equipment which has been abused or damaged by careless handling or shipping. This warranty does not apply to used or demonstrator equipment.

Should any defect develop, Lectrosonics, Inc. will, at our option, repair or replace any defective parts without charge for either parts or labor. If Lectrosonics, Inc. cannot correct the defect in your equipment, it will be replaced at no charge with a similar new item. Lectrosonics, Inc. will pay for the cost of returning your equipment to you.

This warranty applies only to items returned to Lectrosonics, Inc. or an authorized dealer, shipping costs prepaid, within one year from the date of purchase.

This Limited Warranty is governed by the laws of the State of New Mexico. It states the entire liability of Lectrosonics Inc. and the entire remedy of the purchaser for any breach of warranty as outlined above. **NEITHER LECTROSONICS, INC. NOR ANYONE INVOLVED IN THE PRODUCTION OR DELIVERY OF THE EQUIPMENT SHALL BE LIABLE FOR ANY INDIRECT, SPECIAL, PUNITIVE, CONSEQUENTIAL, OR INCIDENTAL DAMAGES ARISING OUT OF THE USE OR INABILITY TO USE THIS EQUIPMENT EVEN IF LECTROSONICS, INC. HAS BEEN ADVISED OF THE POSSIBILITY OF SUCH DAMAGES. IN NO EVENT SHALL THE LIABILITY OF LECTROSONICS, INC. EXCEED THE PURCHASE PRICE OF ANY DEFECTIVE EQUIPMENT.**

This warranty gives you specific legal rights. You may have additional legal rights which vary from state to state.

