

The Freedomike®

Performer

professional
wireless system

Operation and Troubleshooting
Manual



LECTROSONICS



P.O. Box 12617 / 2100 Atrisco Drive, N.W. Albuquerque, N.M. 87195
Telephone: (505) 831-1010 Telex 660431 LECSONICO ABQ

TABLE OF CONTENTS

GENERAL	2
FEDERAL COMMUNICATIONS REGULATIONS	2
M33 TRANSMITTER	3
R33 RECEIVER FRONT PANEL	5
R33 RECEIVER REAR PANEL	6
REMOTE ANTENNAS	7
SYSTEM SETUP AND OPERATION	9
MULTIPLE CHANNEL SYSTEMS	10
TROUBLE SHOOTING	11
SERVICE AND REPAIR	14
RETURNING UNITS FOR REPAIR	14
ACCESSORIES	Table B

1. GENERAL

READ THE MANUAL

This manual contains the functional description, operating instructions and troubleshooting procedures for LECTROSONICS, INC., FREEDOMIKE PERFORMER wireless microphone system. We at LECTROSONICS have endeavored to make the use of the PERFORMER system as simple and foolproof as possible. We want this system to work perfectly for you. The best way to make sure this happens is to read this manual.

The PERFORMER system operates on clear channels in the 30 to 50MHz range. It is available on 5 different frequencies. The M33 transmitter and the R33 receiver must be on the same frequency. The frequency of operation is marked on the serial plate. In addition, the serial plate color is different for each frequency. We have not found that any of the 5 frequencies have any advantages or disadvantages over the others. If more than one system is being used simultaneously, each PERFORMER system must be on a different frequency.

2. FEDERAL COMMUNICATIONS REGULATIONS

F.C.C. regulations require that each M33 series transmitter be licensed by the owner. F.C.C. form 400 together with our instructions for its completion are shipped with each transmitter.

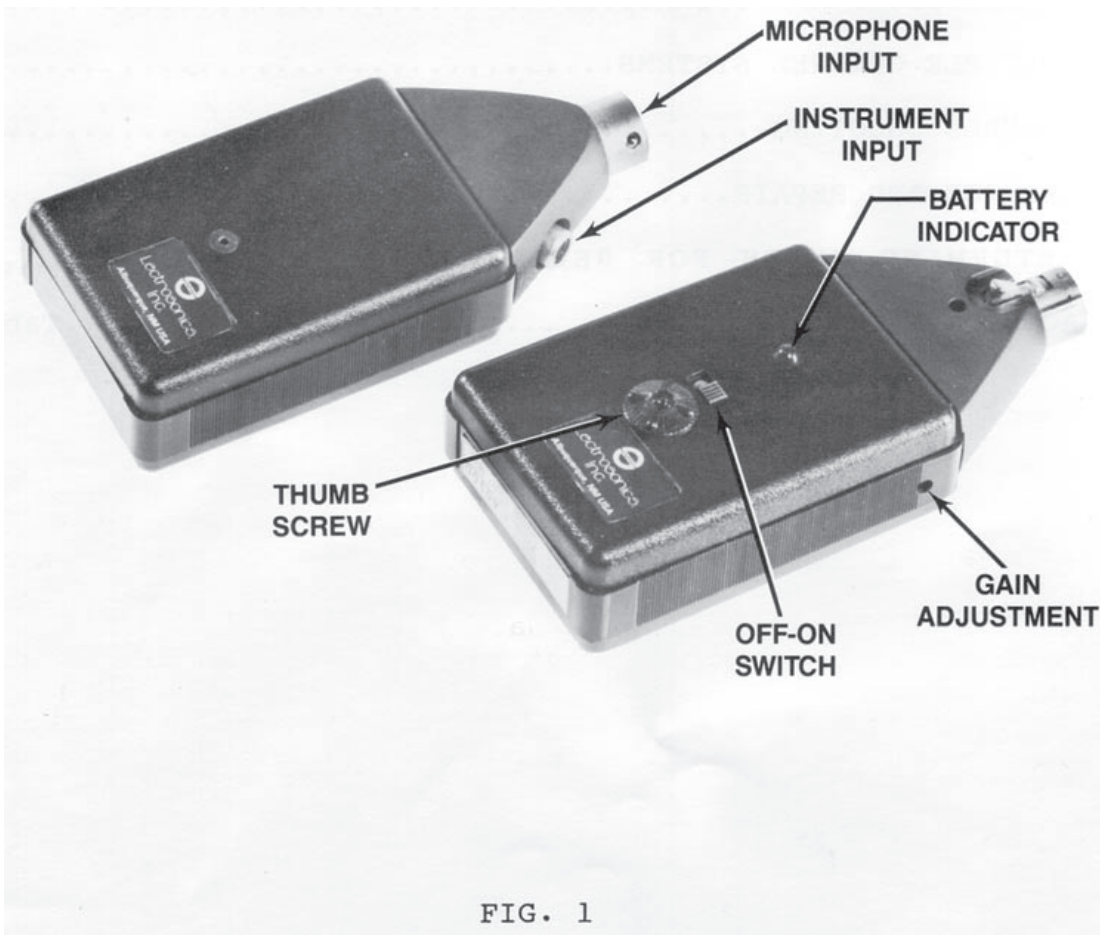

3. M33 SERIES TRANSMITTER (see figure 1)

The **GAIN ADJUSTMENT** sets the audio gain of the M33 to match different performer's microphones or instruments. This adjustment is important to the proper performance of the system and is covered in detail in section 5, SYSTEM SETUP AND OPERATION.

The **INSTRUMENT INPUT** is an RCA phono type with an input impedance of 100k. Use a good quality RCA plug (Switchcraft) to insure a snug, noise free fit.

When the **ON-OFF** switch is pushed to the right it turns on the transmitter. An orange dot will be seen when the switch is in the on position.

The **THUMB SCREW** is turned counterclockwise to remove the side cover in order to replace the battery. The battery will not go into the compartment if it is put in backwards.

The **BATTERY** used in the M33 transmitter should be an Eveready No. 522, Malory MN1604, or equivalent 9 volt alkaline battery (these batteries are available almost anywhere). Carbon zinc batteries, even if marked "heavy duty" or "transistor," will work for only a short while (4 hours or less). In addition, the battery indicator will not function properly.

The BATTERY INDICATOR will blink one time when the M33 is turned on and then go out if the battery is good. If the battery is low, the battery indicator will begin to blink. After the indicator begins blinking you will have about 4 hours of use remaining. When the battery gets very low, the indicator will glow solidly, indicating 1 hour or less remaining.

When the transmitter is first turned on, it may require several minutes to get a "true" battery reading. For example, if a dead battery were not used for a day or so, and then was used in the M33, it might indicate for a minute or so that it was good. This is just like the "dead" batteries in a flashlight that will shine brightly for a few minutes and then rapidly go dim.

When in doubt, throw it out! Your performance is worth more than the few pennies you'll save using questionable batteries. And when you throw them, throw them hard so they can't accidentally get back into the transmitter. You wouldn't believe the number of transmitters we "repair" at LECTROSONICS by putting in a fresh battery.

The **MICROPHONE INPUT** is a standard 3 pin audio connector that will connect to standard microphones. Some early microphones used a 3 pin connector but did not have a balanced output. These microphones will work with the M33 but pins 1 and 2 must be wired together and the output must be on pin 3. Most of these microphones were wired this way originally.

Though the microphone input will work with high impedance microphones it was designed for best performance with a low impedance mic of 50 to 600 ohms. If your microphone has selectable impedance, set or wire it for 150 or 200 ohms.

Some of the most popular microphones come with a set screw that locks the mic cable connector to the bottom of the microphone. This set screw can be used with the M33 connector. We have provided a spare set screw and allen wrench in case you have misplaced the one that came with your mic. You may also drill and tap a 4-40 hole in other microphones to use the set screw. See figure 2 below. If you don't use the set screw, the wavy rubber ring that is provided can be used to remove most of the play between the M33 transmitter and your microphone.

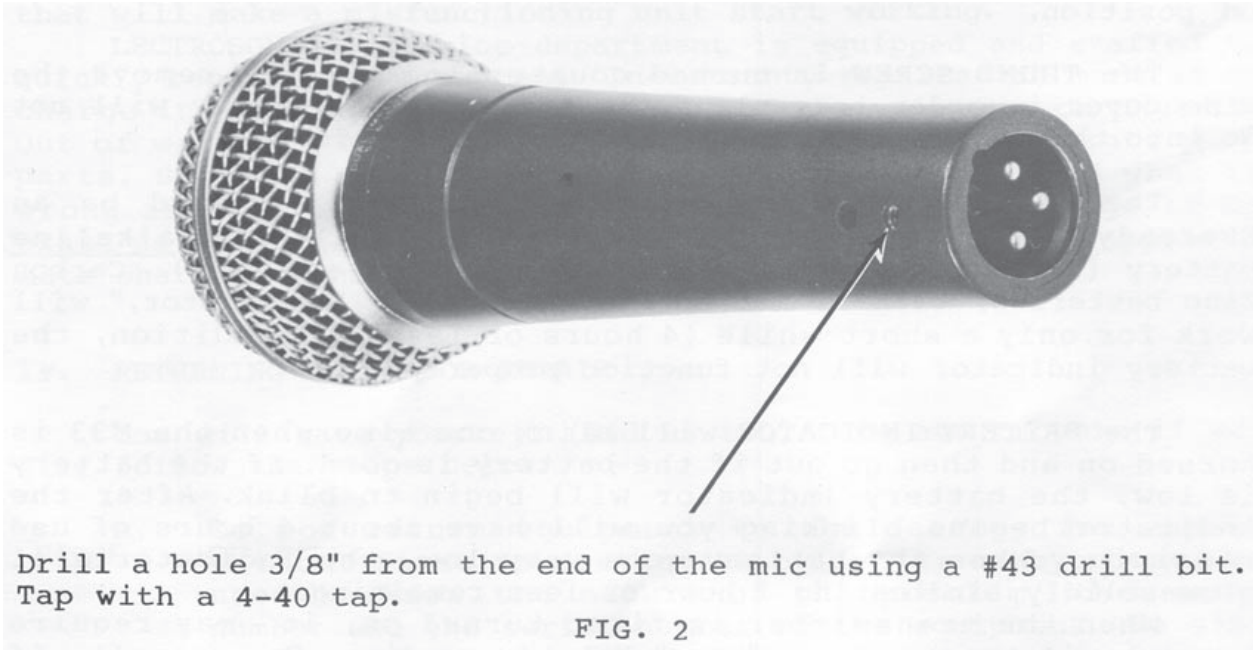

4. R33 RECEIVER FRONT PANEL (see figure 3)

The green LED **RF indicator light** lights when there is sufficient signal from the M33 transmitter for good operation. Internal circuitry detects both signal levels and external interference levels and decides if the transmitted signal has enough strength and is clean enough for satisfactory operation. If the signal is not good enough, then the green RF indicator light turns off and the audio is shut off or “squelched”. Some wireless systems require that the transmitter be on at all times to prevent the receiver from picking up noise or interference. This is not necessary with the PERFORMER due to the superior operation of the squelch circuit. The squelch circuit operates automatically and, unlike some other systems, does not require level adjustments for different environments.

The red LED **PWR indicator light** turns on when the R33 is turned on and has power available.

The green LED **MOD LEVEL** indicator light varies in brightness with the audio level from the transmitter. It is not affected by the volume control or the mute switch on the R33. The indicator operates over a very wide range (-45 to -65 dB) and commonly will light on just background room noise.

The red **MOD LEVEL indicator light** will turn on when the audio signal levels are greater than a preset level (-6 dB). This indicator is similar to the distortion or clipping indicator used on some control boards and amplifiers. However, on this system there is considerably more headroom (16dB) due to the compandor circuitry and soft compressor circuitry built into the transmitter. It is normal for this indicator to flash occasionally during operation. Section 7 will cover in more detail the use of the MOD LEVEL lights in setting up the system.

The **OFF-MUTE-ON switch** has a center position that is used to mute (shut off) the audio outputs without affecting the indicator lamps or changing the level setting. When turning the system on, pause in the MUTE position for a few seconds to allow the circuitry to stabilize. This prevents thumps in the sound system. The MUTE position is also used during setup adjustments to prevent feedback or noise as the transmitter gain is adjusted. The MUTE position can also be used to test the operation of the system without sending a signal to the mixing console.

The **VOLUME control** is an attenuator (output pad) which controls the mic level output and the instrument output on the back of the R33. It does not control the tape output and does not affect the MOD LEVEL indicator lights. The setting of the VOLUME control does not affect noise or distortion levels since it is an output attenuator. The most common setting is fully clockwise at 0 dB. The VOLUME control is used to adjust R33 output levels into your mixing console or instrument amplifier to match the input levels from other instruments or microphones.

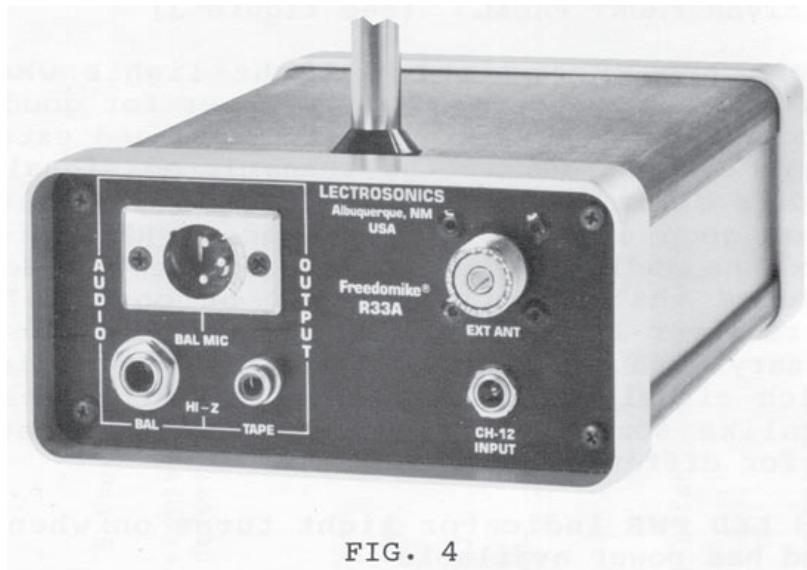

FIG. 4

5. R33 RECEIVER REAR PANEL (see figure 4)

The **BAL MIC (balanced microphone) output**, a switchcraft D3M connector, is the most commonly used output. It is a low impedance (200 ohms, 100 millivolt), balanced output that is essentially the same as a microphone output. This enables the user to place the R33 on stage close to the performer and connect to the stage mic box or snake.

The **HI-Z BAL (balanced high impedance) output** is a 1/4" phone output (1000 Ohms, 1 Volt) that can be used either balanced or unbalanced depending on the phone plug that is used.

The **TAPE output** is an RCA phono output (1500 Ohms, 1 Volt) used to connect to a tape deck. Its output level is not affected by the volume control.

The **EXTERNAL ANTENNA input** matches to a PL259 type connector (standard CB connector) and is used if the R33 is located in an enclosure or at a remote location where the supplied screw-in antenna will not work properly. Instructions for making a remote antenna are on pages 7 and 8.

The **power supply input** will be labeled **CH12 INPUT** on standard R33A receivers or **CH40 INPUT** on R33B receivers that have a built in rechargeable battery pack. The external power supplies are available to match foreign wall outlets and voltages. To connect the power supply, run the plug end of the cable through the nearby strain relief before inserting the plug into the R33.

The battery pack in the R33B receiver will provide up to 16 hours of operation under typical operating conditions. The CH40 charger will recharge the battery from full discharge in 14 hours and also allows operation from an AC outlet. The battery cannot be overcharged.

The reasons for using an external power supply are the elimination of RF hum loops in the supply cord and the elimination of audio ground loops between the mic box on the stage and the control board at the end of the snake. The R33 is not tied to ground by a supply cord but can still meet UL and CSA safety requirements by using approved, external power supplies that don't require grounding.

6. REMOTE ANTENNAS

If the screw in whip antenna provided with the R33 cannot be used due to receiver location, it will be necessary to use a remote antenna. Two antennas will be described; one made from coaxial cable and the other from a modified CB antenna. The coaxial cable antenna is the simplest and has worked well in many installations using our equipment. The coaxial cable is available from an electronics parts store or at Radio Shack. See figure 5 for construction details.

If you decide to use the modified CB antenna, buy only a long (108" antenna. The shorter CB antennas use an inductive loading coil to artificially increase the length. These will resonate at the CB frequencies only and will work poorly with the R33. See figure 6 for construction details.

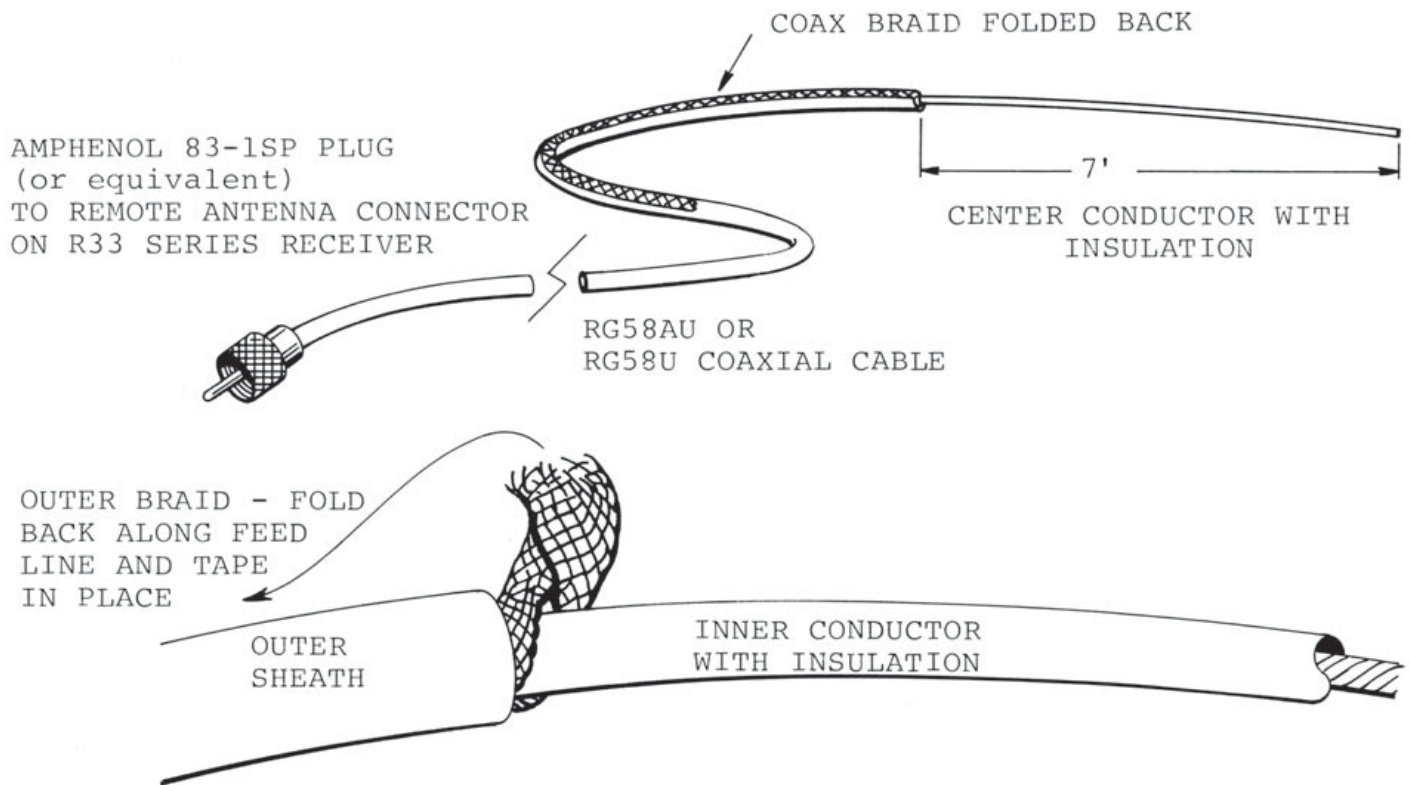

INSTRUCTIONS

1. Remove 7 feet of outer sheath. Use care to avoid damage to the braid.
2. Loosen the braid by pushing it back over the center conductor.
3. Open the braid at its junction with the sheath and pull the center conductor through the hole.
4. Flatten the braid and fold it back along the sheath. Tape the braid to the cable using plastic insulating tape.
5. For best results, try both horizontal and vertical orientation of the antenna.

FIG. 5

REMOTE ANTENNA CONSTRUCTED OF COAXIAL CABLE FOR USE WITH R33 SERIES RECEIVERS

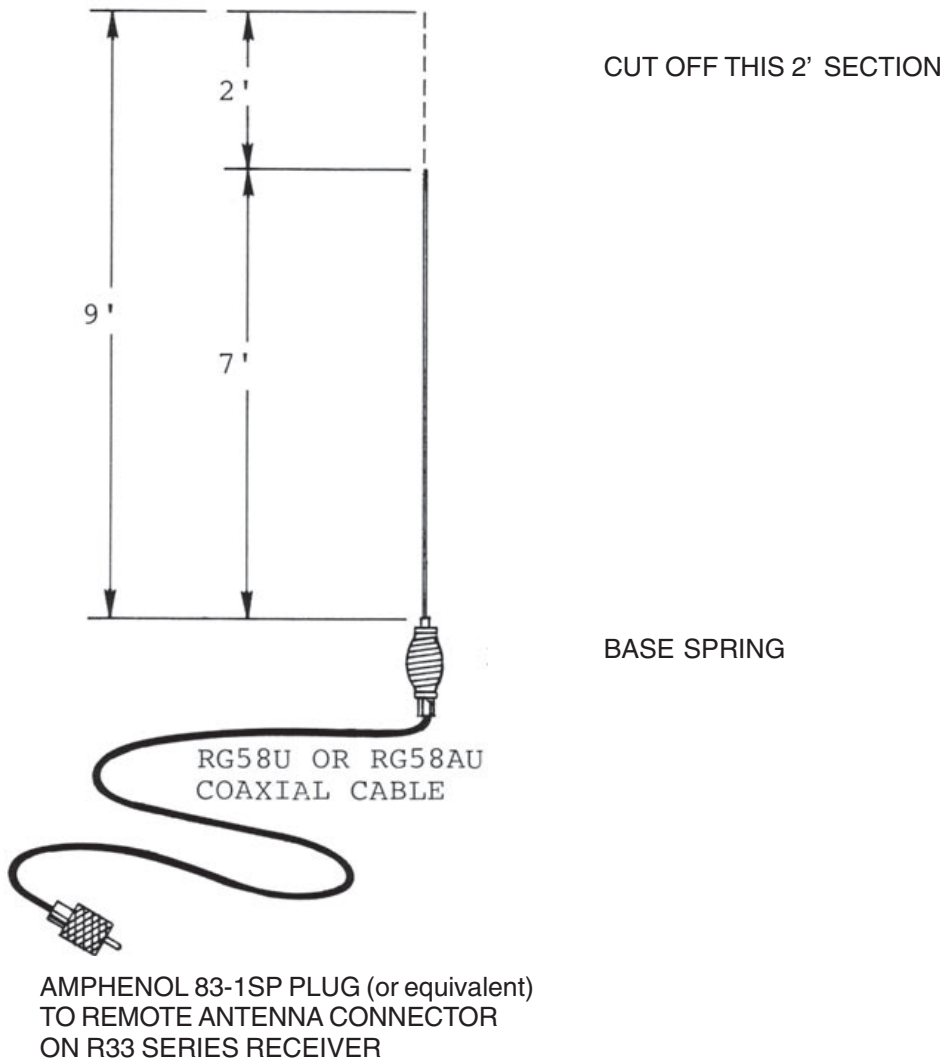

FIG. 6
CB ANTENNA MODIFIED FOR USE
WITH
R33 SERIES RECEIVERS

7. SYSTEM SETUP AND OPERATION

The following steps should be done in order. If you have any problems with the system, make sure all these steps were done correctly.

- A. If you are using the whip antenna that is provided with the R33 receiver, insert the threaded end of the antenna into the hole on top of the receiver and turn it gently clockwise until it is seated. Pull lightly on the antenna to fully extend it but don't lift the receiver by the antenna.
- B. Try to locate the R33 receiver on stage as close to the performer as is reasonable. Choose a location that allows you to extend the antenna fully. Metal surfaces under the receiver such as a table or amp rack are no problem but large metal surfaces next to the antenna may interfere with the reception. You may want to locate the R33 so that the LEDs are visible to the sound system operator.
- C. Connect the appropriate output, connect the power supply and move the OFF-MUTE-ON switch to the MUTE position. The red POWER indicator should light.
- D. Plug the mic or instrument into the M33 transmitter and turn the M33 on. The red battery indicator on the side of the M33 should blink on once. If the indicator continues to blink or stays on, change the battery. When the transmitter is turned on, the green RF indicator on the front of the R33 should light.
- E. The performer should now sing into the attached microphone or play the connected instrument at full level. It is common to play or sing louder during a performance than at a sound check. You may want to take this into consideration during the setup. Adjust the gain of the M33 transmitter using the small plastic screwdriver that is provided. (See figure 1 for the GAIN control location.) The transmitter gain should be adjusted until the red MOD LEVEL lamp blinks occasionally on the loudest audio peaks.

1. A dim green MOD LEVEL lamp indicates the transmitter gain is low. Turn the transmitter gain control gently clockwise until the red LED blinks on the loudest audio peaks.
2. A red MOD LEVEL lamp that is lit at medium audio levels, or very frequently, indicates that the transmitter gain is too high. The gain should be reduced by turning the gain control on the M33 transmitter gently counterclockwise.

Excessive gain may not be audible even on signal peaks since the system is designed to go into compression and, if all else fails, overload "gracefully". However, the resulting compression may restrict the performer's dynamic range and can cause feedback.

Inadequate gain may not be audible because the system has one of the widest dynamic ranges available today. However, **too** low a gain setting may result in a poor signal-to-noise ratio and be audible under extreme conditions such as very quiet rooms or in recording sessions.

If it is impossible to make a sound check in order to adjust the transmitter gain, simply set the gain control all the way counterclockwise (minimum gain). In most cases this will work adequately.

- F. Now that the M33 transmitter gain is set, the R33 receiver OFF-MUTE-ON switch can be switched to the ON position. This will turn on the R33 audio outputs. Your sound system can now be adjusted for the desired audio level. Normally the VOLUME control on the R33 is set at 0 dB (maximum output). If this is too much signal for your system, then set the VOLUME control to the appropriate level.

DO NOT USE THE GAIN CONTROL ON THE TRANSMITTER TO SET THE VOLUME OF THE SOUND SYSTEM. IT IS ONLY USED TO SET THE MODULATION LEVEL AS OUTLINED IN STEP E ABOVE.

- G. With the system on, walk around the area where the transmitter will be used. Sing into the microphone or play the instrument. Check the operation of the system, making sure that the receiver is receiving a good signal (the green RF light should stay on steadily). In the rare case that the signal is lost as you go through a "dead spot", try moving the receiver antenna to a different location.

8. MULTIPLE M33 / R33 SYSTEMS

In multiple wireless system setups there must be an R33 receiver for each M33 transmitter used. Each M33/R33 combination must be on a different frequency. Simultaneous use of more than one M33 transmitter with a single receiver will result in unsatisfactory system operation.

If two M33 transmitters are on the same frequency and are turned on at the same time, the R33 receiver will not receive either of them properly. The weaker or most distant of the two transmitters will not be heard at all and the stronger will have a steady, obnoxious whine in the background. Of course, use of two M33/R33 systems on the same frequency at the same location creates an identical problem. **Each M33 transmitter that is "on" must have a different frequency.**

Each M33 receiver can be hooked up with its own antenna or can be stacked using the remote antenna connector. Figure 7 shows three receivers using one antenna with the remote antenna jacks coupled together using short "stacking" banana plug cords. These are available from your local electronics supply store or from LECTROSONICS as part number MM-8. Up to five receivers can be connected in this manner. When an external antenna is used, it will be necessary to use an Amphenol 83-1T (or equivalent) coaxial "T" connector in order to connect to the second R33 with the MM-8 cord. The "T" connectors and cables are commonly used with CB (citizens band) radios and are available at stores such as Radio Shack.

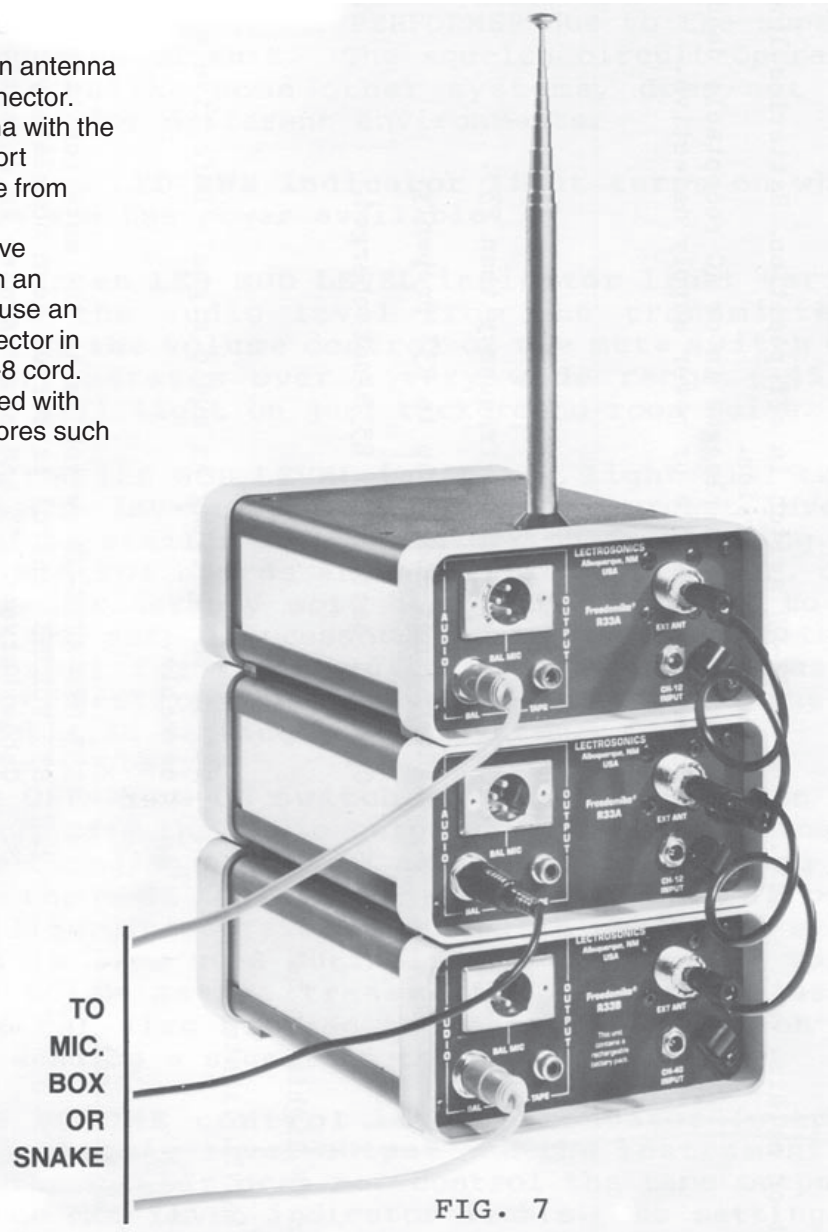

9. TROUBLE SHOOTING

wireless system malfunctions, you should attempt to correct or isolate the trouble before concluding that the equipment needs repair. Make sure you have followed the setup procedures in section 7. Check out the equipment and cabling that connects the wireless to your sound system and then go through the trouble shooting guide in table A on pages 12 and 13.

If this doesn't fix the problem, then go to section 10 for SERVICE AND REPAIR.

TABLE A
TROUBLESHOOTING THE PERFORMER WIRELESS SYSTEM

SYMPTOM	POSSIBLE CAUSE
R33 red POWER light not on or dim.	<ol style="list-style-type: none"> 1. OFF-MUTE-ON switch in off position. Batteries low in R33B rechargeable version. 2. Power supply not plugged in or AC receptacle dead. 3. Power supply cable or power supply defective.
R33 green RF light not on.	<ol style="list-style-type: none"> 1. M33 not turned on. 2. Dead battery in M33. 3. M33 is on different frequency than R33. 4. Antenna not hooked up to R33 properly. 5. Optional battery in R33B not charged.
R33 red POWER and green RF lights on but no audio.	
A. MODULATION LEVEL lights not lighted.	<ol style="list-style-type: none"> 1. M33 is not getting an audio signal. Defective mic, instrument or cable.
B. MODULATION LEVEL lights on.	<ol style="list-style-type: none"> 1. R33 OFF-MUTE-ON switch is in the mute position. 2. R33 VOLUME control is turned down completely. 3. Cable between R33 and sound system is defective. 4. Sound system input off or defective.
System operation normal except for high hiss level.	
A. Red MODULATION light does not flash on during performance.	<ol style="list-style-type: none"> 1. Gain control on M33 set much too low. See section 6 for correct adjustment.
B. Red MODULATION light does flash during performance.	<ol style="list-style-type: none"> 1. Hiss on signal being fed into M33. Disconnect mic or signal source. If hiss stops, problem is in signal source, not with wireless. 2. Hiss in sound system hooked up to R33. Turn the R33 off. If hiss still remains, then the hiss is in the sound system.
System operation normal except excessive hum level.	<ol style="list-style-type: none"> 1. See above procedure for hiss level and follow the same steps.
System operation normal except for excessive feedback during quiet portions of vocals and singer is having difficulty hearing monitors during loud portion of vocals.	<ol style="list-style-type: none"> 1. M33 gain set much too high. The red MODULATION LEVEL light will be on much of the time. See section 6 for correct adjustment.

TABLE B

REPLACEMENT PARTS AND ACCESSORIES

CAT. NO.	ITEM DESCRIPTION	USE
A-54	Antenna, telescoping, 54"	Replacement antenna for R33 series receivers
CC-FF	Carrying case	Molded carrying case for PERFORMER system and accessories
CH-12	Power Supply	External power supply for R33A receivers, AC only
CH-40	Power supply / battery charger	External Power supply for R33B rechargeable receivers
CP-25	25' cable, (A3M, A3F)	25' mic cable, male/female, (3 pin audio) for R33 mic level output
CP-50	50' cable, (A3M, A3F)	50' mic cable, male/female, (3 pin audio) for R33 mic level output
MM-8	8" cord, banana plugs	For multiple frequency R33 receiver systems - see section 8.
MM-36	36" cord, male phono plugs	For connecting HI LEVEL OUT to standard sound system input
MM-50	50' cord, male phono plugs	For connecting HI LEVEL OUT to standard sound system input at a distance
P-33	Pouch, M33 transmitter	Pouch with belt clip for M33 when using the instrument input

A 13 C D
 47 50 22
 34 47 22
 33 33 15
 22 22 17
 21

3/11/87
 CH 6C
 CH II
 CH I

SCORIAL WORKBENCH
 XX 300 & ABOVE
R33
 ELECTRONICS, Inc.
 2100 Atascadero, CA 92011
 1-805-831-1010

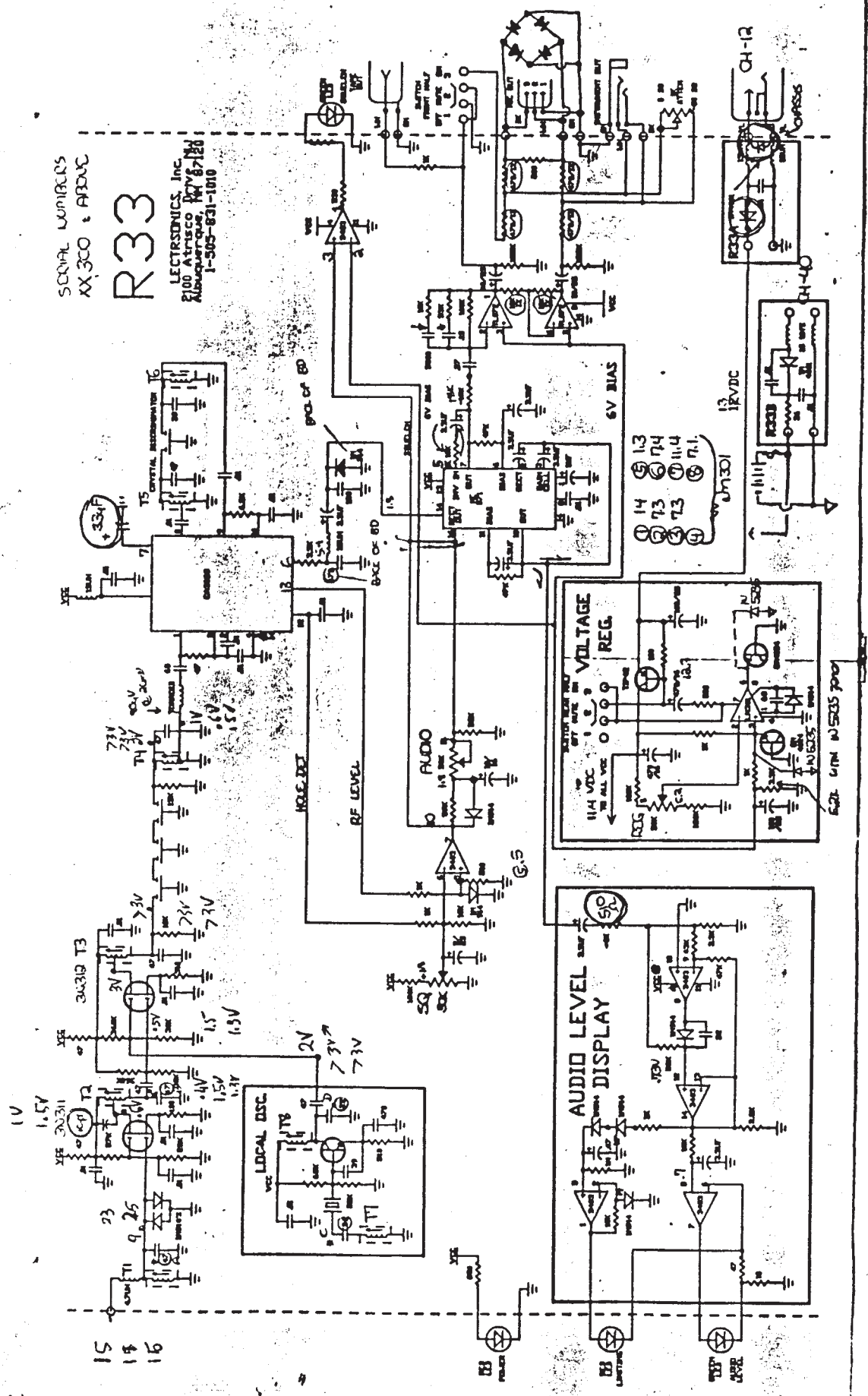

ALL MEASUREMENT TAKEN WITH RF MILLIVOLTMETER AT 42.98 MHZ, SHORT GND LEAD.
 RF GENERATOR SET AT +10mV NO MODULATION. ALL VALUES IN mV.

LECTROSONICS, INC.

581 LASER ROAD
RIO RANCHO, NM 87124 USA
www.lectrosonics.com

January 12, 2005
(Created from old paper copy.)