

UCR401

Compact Wireless Receiver



Featuring Digital Hybrid Wireless[®] Technology

U.S. Patent 7,225,135

Fill in for your records:

Serial Number:

Purchase Date:

Digital Hybrid Wireless™

The Lectrosonics Digital Hybrid Wireless™ uses innovative technology to combine the new advantages of digital audio with the advantages of analog RF transmission, thus delivering the superior sound quality of a digital system and the excellent range of an analog system. A proprietary algorithm encodes the digital audio information into an analog format which can be transmitted in a robust manner over an analog FM wireless link. The receiver employs state-of-the-art filters, RF amplifiers, mixers and detector to capture the encoded signal and a DSP recovers the original digital audio.

This digital/analog hybrid technique has some very beneficial properties. Because the information being-transmitted is digitally encoded, immunity to noise is much higher than a compandor can offer. Because the encoded audio is sent in analog format, spectral and power efficiency and operating range are not compromised.

Under weak RF conditions, the received signal degrades gracefully, like an analog system, delivering as much usable audio as possible at maximum range. Since the audio is free of compandor artifacts, pumping and breathing problems are also greatly reduced.

Table of Contents

General Technical Description	7
Front Panel Controls and Functions	10
LCD Screen	10
MENU Button	10
SELECT Up/Down Buttons	10
Power ON/OFF Switch	10
Rear Panel Features	10
XLR Audio Output Jack.....	10
Power Input Jack.....	10
Main Window (LCD)	11
Menu Selections from Main Window	12
Frequency Window.....	12
Battery Level Window	12
Setup Window	13
LEVEL.....	13
TONE	13
TXBAT.....	13
PHASE.....	13
SmtNR	13
TUNING	14
COMPAT	14
Frequency Scan Mode	15
Scan & View Window Elements	15
Fine View Window Elements.....	15
Antenna Orientation	16
Setup and Operating Instructions	17
Installing/Replacing Batteries.....	17
Adjusting Audio Output	17
Finding Clear Frequencies.....	18
Locking and Unlocking the UCR401	19
Pre-coordinated Frequencies	20
Frequency Coordination	21
Multi-channel System Checkout	21
Pilot Tone Bypass	22
Replacement Parts and Accessories	23
Mating power plug dimensions	23
Troubleshooting	24
Specifications and Features	26
Service and Repair	27
Returning Units for Repair	27

General Technical Description

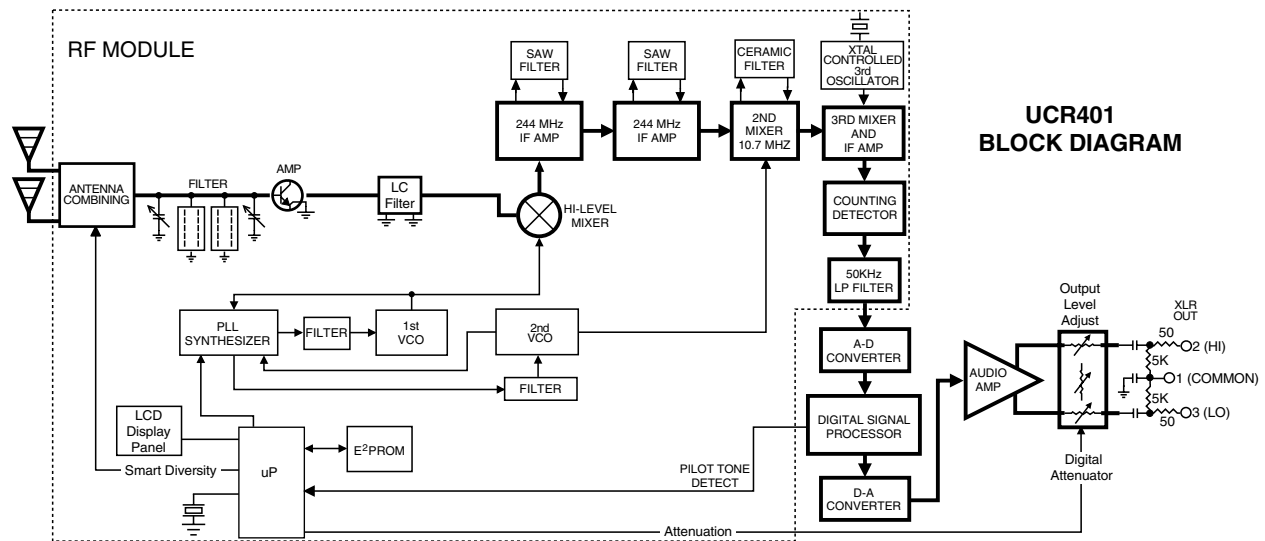

The UCR401 is a portable, high performance, triple-conversion, frequency synthesized, UHF receiver fully compatible with all Lectrosonics 400 Series transmitters, Lectrosonics wideband UHF analog systems. DSP compatibility modes also provide compatibility with some other transmitter brands. The RF performance is extremely stable over a very wide temperature range, making the UCR401 perfectly suited to the rough environmental conditions found in field production. The combination of digital audio with analog RF produces superb audio quality and extended operating range.

The UCR401 front panel features a menu-driven LCD interface and three control buttons to conveniently view and alter user settings. The main LCD window simultaneously displays the pilot tone indicator, phase diversity activity, RF level, audio level, battery status for both transmitter and receiver. It is also possible to bypass the pilot tone squelch from the main display window for diagnostic purposes. Other windows display operating frequency, audio output level, battery voltage and test tone status.

A built-in spectrum analyzer scans across the tuning range of the receiver to locate RF signals in the vicinity and find clear operating frequencies.

Diversity Reception

Microprocessor controlled antenna phase combining keeps the receiver small, with low power consumption, yet it is still able to deal effectively with multi-path dropouts. SmartDiversity™ analyzes both the incoming RF level and the rate of change in RF level to determine the optimum timing for phase switching, and the optimum antenna phase. This adaptive technique operates over a wide range of RF levels to anticipate dropouts before they occur. The system also employs “opportunistic switching” to analyze and then latch the phase in the best position during brief squelch activity.

RF Front-End and Mixer

The UCR401 is frequency agile and can be set to operate on any one of 256 frequencies within its tuning range. To significantly reduce unwanted interference and intermodulation problems, the UCR401’s front-end is tuned to the desired frequency band and rejects or “tunes out” unwanted out-of-band signals. Two tuned HI-Q ceramic transmission line resonators prior to a low noise, high current RF amplifier provide good selectivity. A LC bandpass filter after the RF amplifier provides added insurance against strong RF interference, and the first mixer has a very high third order intercept point. The overall design ensures stability, selectivity and precise gain in order to handle strong RF signals without input overload.

Microcontroller, PLL and VCO Circuits

The 8-bit microprocessor is truly the “heart” of the UCR401 receiver. It monitors user command inputs from the front panel control buttons and numerous other internal signals such as RF level, audio levels, pilot tone levels and external/internal power voltages. Outputs from the microcontroller drive the LCD display and backlight, control the squelch and audio output attenuator, and operate the front-end tuning, the PLL/VCO circuits and the antenna phase switch. The UCR401 design and the advanced technology of the microprocessor control arguably set a new standard in wireless microphone development.

IF Amplifiers and SAW Filters

The first IF stage at 244 MHz employs two state-of-the-art SAW (surface acoustic wave) filters. The use of two filters significantly increases the depth of filtering while preserving sharp skirts, constant group delay, and wide bandwidth. Though expensive, this special type of filter allows primary filtering as early as possible, at as high a frequency as possible before high gain is applied to the signal for maximum image rejection.

Since these filters are made of quartz, they are very temperature stable. After the SAW filter, the 244 MHz IF signal is converted to 10.7 MHz IF and then to the low frequency of 300 kHz. Only then is the majority of the gain applied, just before the signal is converted to audio with a pulse counting detector. Although 300 kHz is very unconventional for an IF in a wide deviation (± 75 kHz) system, it offers outstanding AM rejection figure over a very wide range of signal strengths and produces an excellent noise improvement at low signal strengths.

Digital Pulse Counting Detector

The UCR401 receiver uses an elegantly simple, yet highly effective digital pulse detector to demodulate the FM signal, rather than a conventional quadrature detector. This unusual design eliminates thermal drift, improves AM rejection, and provides very low audio distortion.

DSP-Based Pilot Tone

The Digital Hybrid system design uses a DSP generated ultrasonic pilot tone to control the receiver audio muting (squelch). Brief delays are applied to eliminate thumps, pops or other transients that can occur when the power is turned on or off. The pilot tone frequency is different for each of the 256 frequencies in the tuning range of a system (frequency block). This eliminates squelch problems in multichannel systems where a pilot tone signal can appear in the wrong receiver via intermodulation products. The DSP generated pilot tone also eliminates fragile crystals, allowing the receiver to survive shocks and mishandling much better than older analog-based pilot tone systems.

Note: This description applies only in 400 Series mode. In 200 Series mode, only one pilot tone frequency is used on all channels, emulating the original crystal-based system. In other compatibility modes, no pilot tone is used.

Smart Squelch™

Any squelching system faces inevitable trade-offs: squelch too aggressively and valuable audio information may be lost. Squelch too little and excessive noise may be heard. Respond too rapidly and the audio will sound “choppy.” Respond too sluggishly and syllables or entire words can be cut off.

The UCR401 combines several techniques to achieve an optimal balance, removing distracting noise, without the squelching action itself becoming a distraction. One of these techniques involves waiting for a word or syllable to complete before squelching. Another technique

incorporates recent squelching history and recent signal strength, adjusting squelching behavior dynamically for the most serviceable result under variable conditions. Using these and other techniques, the UCR401 can deliver acceptable audio quality from otherwise unusable signals.

Smart Noise Reduction (SmartNR™)

Note: The SmartNR setting is user selectable only in 400 Series mode. In other modes, noise reduction is applied in such a way as to emulate the original analog system as accurately as possible and is not user adjustable.

The UCR401 has been meticulously designed using the best available low noise components and techniques. Nonetheless, the wide dynamic range of digital hybrid technology, combined with flat response to 20 kHz, makes it possible to hear the -120 dBV noise floor in the mic preamp, or the (usually) greater noise from the microphone itself. To put this in perspective, the noise generated by the recommended 4 k bias resistor of many electret lavalier mics is -119 dBV and the noise level of the microphone's electronics is much higher. In order to reduce this noise the UCR401 is equipped with a Smart Noise Reduction algorithm, which removes hiss without sacrificing high frequency response.

The Smart Noise Reduction algorithm works by attenuating only those portions of the audio signal that fit a statistical profile for randomness or “electronic hiss.” Because it isn't simply a sophisticated variable low pass filter as in Lectrosonics's 195 and 200 series analog designs, much greater transparency is obtained. Desired high frequency signals having some coherence are not affected, such as speech sibilance and tones.

The Smart Noise Reduction algorithm has three modes, selectable from a user setup screen: OFF, NORMAL, and FULL. When switched OFF, no noise reduction is performed and complete transparency is preserved. All signals presented to the transmitter's analog front end, including any faint microphone hiss, will be faithfully reproduced at the receiver. When switched to NORMAL, enough noise reduction is applied to remove most of the hiss from the mic preamp and some of the hiss from lavalier microphones. The noise reduction benefit is significant in this position, yet the degree of transparency maintained is exceptional. When switched to FULL, enough noise reduction is applied to remove most of the hiss from nearly any signal source of reasonable quality, assuming levels are set properly at the transmitter, and some high frequency environmental noise. The optimal setting for each application is subjective and selected while simply listening.

Supersonic Noise-Based Dynamic Filter and Squelch

In addition to SmartNR, all hybrid receivers are equipped with a supersonic noise-based dynamic filter and squelch system. The incoming audio is monitored for energy above 22 kHz, pilot tone excepted. Excessive high frequency energy indicates that the received signal is too weak to achieve an acceptable signal-to-noise ratio. Under marginal conditions, a variable low pass filter is rolled in dynamically, masking the noise while preserving as much of the transmitted signal as possible. When the channel is too noisy even for the filter, the audio is squelched.

This noise-based filter and squelch system replaces a more or less equivalent system used for many years, which based its operation on RF signal strength. Performance of the two systems is virtually identical, but the noise-based system requires no calibration and there is no better way to track the signal-to-noise ratio than to measure it directly.

RF-Controlled Digital Noise Filter

In extremely weak signal conditions, an RF sensitive variable frequency filter is applied to reduce the high frequency response of the receiver. This filter does nothing until the RF signal strength drops below 3 uV at which point it begins to roll off high frequencies. Usable audio remains unaffected, but noise-ups or “hits” occurring near the fringe of reception sound much less harsh.

Audio Output Level

A setup screen is provided for adjusting the audio output level in 1 dB increments from -50 to +5 dBu using the front panel SEL Up and Down buttons.

Test Tone

To assist in matching the audio levels of equipment connected to the UCR401, a 1 kHz audio test tone, adjustable from -50 to +5 dBu in 1 dB increments, is available at the XLR connector. This tone is available through the TONE display window.

Batteries

The UCR401 operates on two AA 1.5 Volt alkaline, lithium or NiMH batteries. Access to the battery compartment is gained by lifting one end and turning the rear panel door.

Note: Do not mix battery types in the same unit. Also, standard or “heavy duty” batteries are not recommended.

Power Supply

The UCR401 may be operated from an external DC power source. The power supplies are protected from damage to the receiver that could occur if a positive ground power source is applied.

LCD Display

The display has four primary windows. Pressing the Front Panel MENU button steps through each of these windows.

If the battery gets low on either transmitter or receiver, a message will interrupt the display every few seconds and flash a low battery warning.

After power is turned off and back on again, the unit defaults to the main window and to the most recent frequency, audio level, transmitter battery type and other user settings. These settings are retained even if the batteries are removed. After five minutes of no key activity, the LCD backlight goes off and the display reverts back to the main window.

Power Up Sequence

The power up sequence consists of four messages that appear automatically after the power is switched on.

- 1) UCR401
BLK xx (xx is the frequency block number)
- 2) VERSION
R.R/A.A (R.R is the RF board firmware version, A.A is the audio board firmware version)
- 3) COMPAT
mode (mode is one of the following:
400 - Native 400 Series mode
100 - Lectro 100 Series compatibility
200 - Lectro 200 Series compatibility
MODE 3 - compatible with certain non-Lectrosonics transmitters)
IFB - compatible with all Lectrosonics IFB transmitters.
MODE 6 - compatible with certain non-Lectrosonics transmitters)
- 4) TUNING
mode (mode is one of the following:
NORMAL - tune in single channel increments
GRP x - tune in precoordinated intermod-free frequencies (x is A, B, C, D, U or V))

The Main Window appears after the introductory messages are displayed.

The UCR401 is fully operational during the power up sequence and will immediately respond to button pushes made before the automatic sequence is completed. If a valid transmitter signal is already present when the receiver is turned on, the audio output will typically be engaged somewhere in the middle of the power-up sequence, following a brief delay to allow the audio circuits to stabilize.

Power Off

When the Front Panel Power ON/OFF switch is moved to the OFF position, the audio output is instantly muted (squelched) and the message “POWERING OFF...” is displayed briefly before the receiver switches off.

Front Panel Controls and Functions



LCD Screen

The LCD Screen is a graphics-type Liquid Crystal Display that is used to monitor system operation and configure the UCR401.

SELECT Up/Down Buttons

The SELECT Up/Down buttons are used to select various options within each display selection and for setting the operating frequency of the receiver.

MENU Button

The MENU button steps through the four primary windows and setup screens.

Power ON/OFF Switch

The Power ON/OFF switch is used to apply battery or external power to the unit.

Rear Panel Features



XLR Audio Output Jack

This is a standard XLR configuration with pin 2 “positive” with reference to handheld and plug-on transmitters. With lavalier microphones and belt-pack transmitters, however, phase will vary with different types of microphones (2-wire versus 3-wire for example). The audio output is balanced but not floating, so an unbalanced signal is available using pin 1 as ground and pin 2 as signal, leaving pin 3 open.

Note: The external power source must have its own short-circuit protection

Strain relief to avoid accidental disconnection can be provided with the included small hook and loop strip. Attach the adhesive strip side to the side of the receiver or mount with the opening end of the strip up - place the cable in the strip and secure.

Power Input Jack

The power input jack can accept 6-18 VDC - the center pin is positive and sleeve is ground. The input is diode protected to prevent damage if the power is applied with reversed polarity, but the unit will not work until the reversed polarity condition is fixed. The jack and plug feature twist-lock retention. The Power Input Jack will also accommodate non-locking plugs.

Velcro Strain Relief

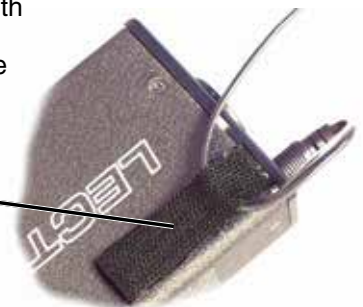



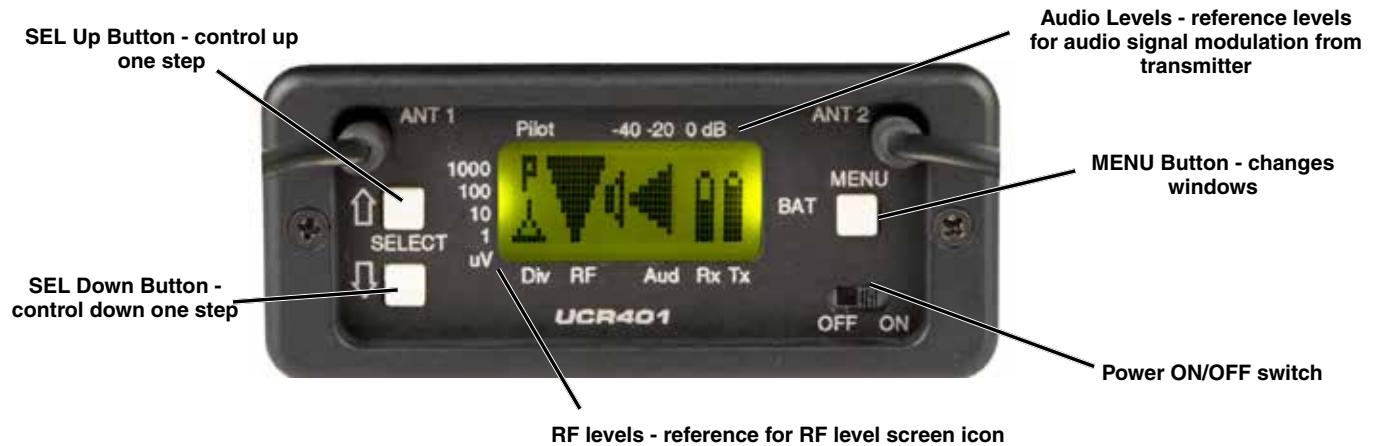

Main Window (LCD)



The Main Window displays information concerning the condition of the Pilot Tone, antenna phase, RF and audio signal levels and battery conditions for both the receiver and the associated transmitter. It is also the

access portal to menu selections for setting up the receiver and searching for clear frequency channels. (See Menu Selections from Main Window and Frequency Scan Mode.)

Icon	Description
	<p>Pilot Tone Indicator</p> <p>A steady “P” icon will be displayed when a pilot tone from the transmitter is present. The “P” will appear only in those compatibility modes which use pilot tone: 200 Series and the native 400 Series modes, plus Mode 6. The icon will flash if no pilot tone is detected and will change to a small “b” if the pilot tone has been bypassed. To bypass the pilot tone, hold MENU and press the UP button. Hold MENU and press UP again to restore normal pilot tone squelch. Bypassing the pilot tone also disables the squelch, so the “pilot tone bypass” function has an effect even in those compatibility modes that do not use pilot tone.</p>
	<p>Antenna Phase Indicator</p> <p>This icon shows antenna phase switching activity. As the antenna phase is switched, the symbol will flip vertically.</p>
	<p>RF Level</p> <p>This icon changes in size vertically to indicate the strength of the incoming RF signal. RF levels are engraved on a scale from 1uV to 1000uV on the bezel to the left of the LCD display.</p>
	<p>Audio Levels</p> <p>This icon changes in size horizontally to indicate the audio level (modulation) of the signal received from the transmitter. The icon display will change to a solid rectangular block when the audio signal is being limited in the transmitter. Levels in dB are engraved into the bezel above the LCD display.</p>
	<p>Battery Levels</p> <p>The icon above the Rx symbol indicates the receiver battery condition and will flash when approximately one hour of operating time is remaining. When external power is being used, the Rx battery icon changes to look like a power plug. The area above the Tx symbol features either a transmitter battery status icon or the transmitter battery timer, depending on the TXBAT setting. The transmitter battery status icon is available only in compatibility modes supporting battery telemetry (400 and 200 Series). In such cases, the transmitter battery status icon appears 5 to 10 seconds after the transmitter signal is acquired. If selected in the TXBAT setup screen, the transmitter battery timer is available in any compatibility mode. It accumulates hours and minutes that the communications link is active, retaining the timing even when the receiver is off.</p> <p><i>Note: To reset the battery timer, press and hold MENU and SELECT Down together for one second.</i></p>

Menu Selections from Main Window

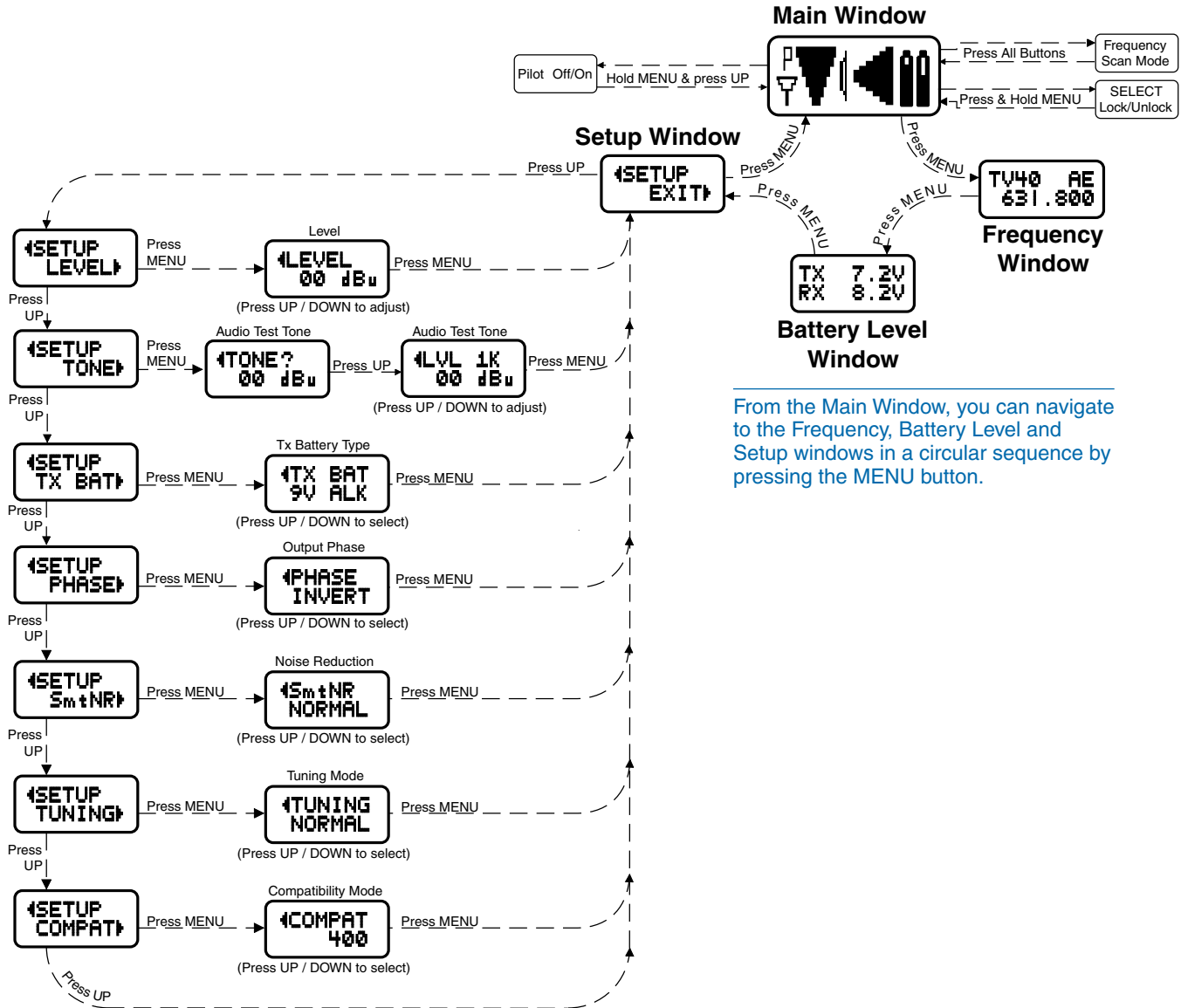

From the Main Window, you can navigate to the Frequency, Battery Level and Setup windows in a circular sequence by pressing the MENU button.

Frequency Window

TVxx - The television broadcast channel the frequency falls within.

Transmitter switch settings (AE in the illustration) - These are the correct settings for the frequency switches on your transmitter - see your transmitter instructions.

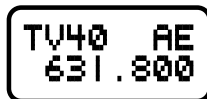

Frequency - Press the SEL Up and Down buttons to change the frequency of the receiver.

Note: Be certain to change the transmitter frequency switches to match the settings shown in the upper right hand corner of the Frequency window.

When the TUNING mode is set to NORMAL, the SEL Up and Down buttons tune in single channel increments. In the GROUP tuning modes, the SEL Up and Down buttons move among the selected intermod-free frequencies.

Battery Level Window

This window shows the transmitter (TX) and receiver (RX) battery voltage. These levels will flash when the voltages drop below suggested optimum working levels. Typically, there will be about one hour operating time remaining after the indicators begin to flash. The RX voltage changes to EX when operating on external power and displays the external power source voltage. *(Disclaimer: We cannot guarantee 0.1 Volt accuracy.)*

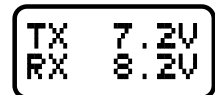

Setup Window

In the Setup window, the SEL Up and Down buttons scroll through a list of eight possible setup screens: EXIT, LEVEL, TONE, TXBAT, PHASE, SmtNR (in 400 Series mode only), TUNING and COMPAT. Each of these destinations allows a variety of settings to customize the receiver operating parameters. Pressing the MENU button accesses whatever setup screen is identified in the Setup window. Pressing the MENU button whenever EXIT is displayed returns the user to the Main Window.



◀SETUP
EXIT▶

LEVEL

The **LEVEL** setup screen displays the audio output level of the receiver in dBu. Use the SEL Up or Down buttons to change the level. Range is from -50 to +5 dBu in 1 dB steps. Press the MENU button to leave this screen.



◀LEVEL
00 dBu

TONE

The **TONE** setup screen enables an audio test tone at the receiver output for precise level matching with other equipment. The first screen prompts you to press the SEL Up button to enable the tone at the receiver output jack. The next screen that appears allows the level to be adjusted in 1dB steps using the SEL Up and Down buttons.



◀TONE?
00 dBu

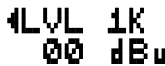

◀LVL 1K
00 dBu

When the audio test tone is enabled, the received audio is muted and an internally generated 1 kHz test tone is routed to the XLR connector. Since there is only one audio output level setting for both received audio and tone, the level set here will be retained in the receive mode (it will supersede the setting made in the LEVEL setup screen). The test tone has 1% distortion and is intended for confirmation of output levels only. To exit the test tone screen and stop the tone press the MENU button.

TXBAT

The **TXBAT** setup screen allows you to select the exact battery being used in the transmitter to provide more accurate battery level monitoring. Four different types of batteries are commonly used in Lectrosonics transmitters: 9 Volt alkaline, 9 Volt lithium, AA alkaline, and AA lithium. Correctly set, this will ensure that adequate warning will be provided in advance of battery failure. Use the SEL Up and Down buttons to select the transmitter battery. Press MENU to leave this screen.



◀TX BAT
9V ALK

In native 400 Series mode as well as in the 200 Series compatibility mode, the TXBAT menu offers six choices:

9V ALK - Transmitter uses a 9V alkaline battery. Monitor voltage with battery icon in main window.

9V LTH - Transmitter uses a 9V lithium battery. Monitor voltage with battery icon in main window.

9V TIM - Transmitter uses a 9V battery. Display its voltage normally in the battery level window but monitor its status with the battery timer in the main window.

AA ALK - Transmitter uses a AA alkaline battery. Monitor voltage with battery icon in main window.

AA LTH - Transmitter uses a AA lithium battery. Monitor voltage with battery icon in main window.

AA TIM - Transmitter uses an AA battery. Display its voltage normally in the battery level window but monitor its status with the battery timer in the main window.

The 9V TIM and AA TIM settings are most useful for NiMH batteries as they do not exhibit reliably identifiable voltage drops as they discharge.

In compatibility modes other than 400 Series and 200 Series, no battery telemetry information is available so the TXBAT setup screen offers only two choices:

NOTIMER - Display no transmitter battery status in the main window.

TIMER - Monitor the transmitter battery status with the battery timer in the main window.

Note: To reset the battery timer, press and hold MENU and SELECT Down together for one second.

PHASE

The output **PHASE** setup screen allows the audio output phase to be inverted. The SEL Up and Down buttons can be used to toggle between normal and inverted phase. Press MENU to leave this screen.



◀PHASE
INVERT

SmtNR

The **SmtNR** (Smart Noise Reduction) setup screen (available in 400 Series compatibility mode only) places the Smart Noise Reduction algorithm in one of three modes. In the OFF position, no noise reduction is applied, for complete transparency. In the NORMAL position (factory default setting), a moderate amount of noise reduction is applied, dramatically reducing hiss with virtually no discernible side effects. In the FULL position, the transparency is superior to the Lectrosonics noise reduction system used for many years in the 195 and 200 series systems. Try switching between the three modes to decide what setting is correct for your application. Refer to the Smart Noise Reduction section in the GENERAL TECHNICAL DESCRIPTION chapter for more detailed information about this feature.



◀SmtNR
OFF



◀SmtNR
NORMAL



◀SmtNR
FULL

TUNING

The Tuning setup screen allows selection of one of four factory set frequency groups (Groups A through D), two user programmable frequency groups (Groups U and V) or the choice to not use groups at all.



In the four factory set frequency groups, eight frequencies per group are preselected. These frequencies are chosen to be free of intermodulation products. (See Frequency Coordination.)

In the two user programmable frequency groups, up to 16 frequencies can be programmed per group.

Note: The Tuning Setup Screen only selects the tuning mode (NORMAL or Group Tuning) and not the operating frequency. Actual operating frequencies are chosen through the Frequency Window.

If NORMAL tuning mode is selected, the SEL Up and Down buttons select the operating frequency in single channel (100 kHz) increments and the MENU+Up and MENU+Down shortcuts tune in 16 channel (1.6 MHz) increments.

There are two group tuning modes: factory preset groups (Grp A through D) and user programmable frequency groups (Grp U and V).

In these modes, the SEL Up and Down buttons navigate among the selected intermod-free frequencies in the group (and the MENU+Up and MENU+Down shortcuts jump to the first and last frequencies in the group.)

Also, a lower case a, b, c, d, u or v will be displayed to the immediate left of the transmitter switch settings in the Frequency Window. The letter identifies the selected factory or user tuning group.

Any time the currently tuned frequency is not in the current tuning group, the group tuning mode indicator will blink. Any time the currently tuned frequency is in the current tuning group, the group tuning mode indicator will give a steady (non-blinking) indication.

If a factory tuning group has been selected, pressing either the SEL Up or Down button will select the nearest factory selected frequency in that group above or below the current frequency.

User Programmable Frequency Group Behavior

The user programmable frequency groups “U” or “V” work very similarly to the factory groups with a few exceptions. The most obvious difference is the ability to add or remove frequencies from the group. Less obvious is the behavior of a user programmable frequency group with only one, or no entries.

A user programmable frequency group with only one entry continues to display the single frequency stored in the group no matter how many times the SEL Up or Down buttons are pressed (provided the MENU button is not pressed at the same time). The “U” or “V” will not blink.

A user programmable frequency group with no entries reverts to non-group-mode behavior, i.e., access is allowed to all 256 available frequencies in the selected receiver module’s frequency block. When there are no entries, the “U” or “V” will blink automatically. However, once a frequency has been added to the tuning group, this behavior changes to group-mode behavior where the MENU button must be pressed and held while either the SEL Up or Down buttons are pressed to access frequencies that are not part of the current tuning group.

Adding/Deleting User Programmable Frequency Group Entries

Note: Each User Programmable Frequency Group (“u” or “v”) has separate contents. We recommend that you review the section titled Frequency Coordination prior to adding frequencies in order to minimize potential intermodulation problems.

1. Start from the Frequency Window and verify that a lower case “u” or “v” is present next to the transmitter switch settings.
2. While pressing and holding the MENU button press either the SEL Up or Down button to move to one of the 256 available frequencies in the block. Whenever the selection comes to rest on a frequency that is in the current group, the group tuning mode indicator (letter “u” or “v”) will give a steady indication. On frequencies that are not in the group, the indicator will blink.
3. To add or remove the displayed frequency from the group, hold down the MENU button while pressing and holding the SEL Up button. The group tuning mode indicator will stop blinking to show that the frequency has been added to the group, or begin blinking to indicate that the frequency has been removed from the group.

COMPAT

The **COMPAT** setup screen selects the type of transmitter used with the UCR401. The available modes are:



400 - Lectrosonics 400 Series.

This is the default setting and should be used if your transmitter supports it. This mode offers the best audio quality.

100 - Lectrosonics 100 Series compatibility mode.

200 - Lectrosonics 200 Series compatibility mode.

IFB - Lectrosonics IFB compatibility mode.

MODE 3 and **MODE 6** - Compatible with certain non-Lectrosonics transmitters.

Frequency Scan Mode

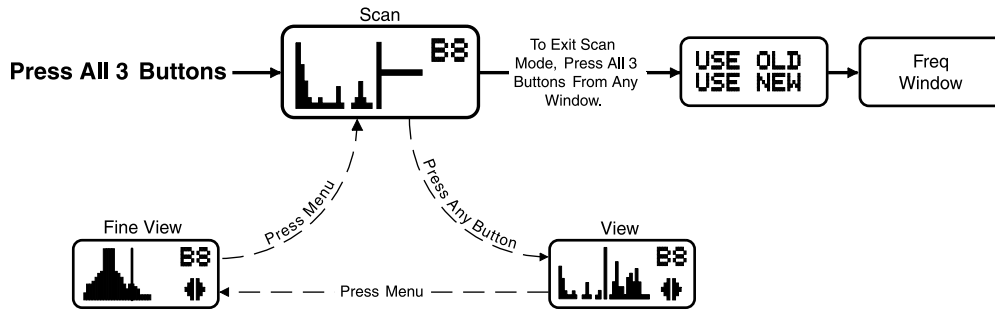

Scan & View Window Elements

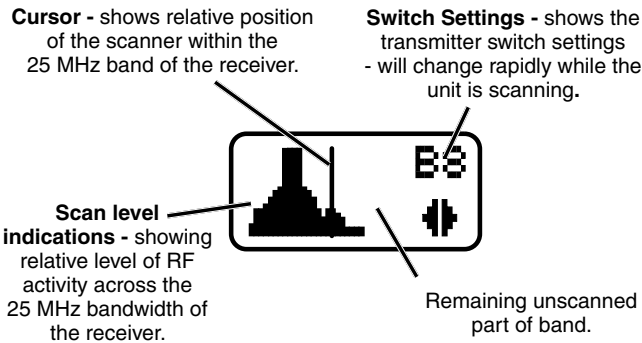

Fine View Window Elements

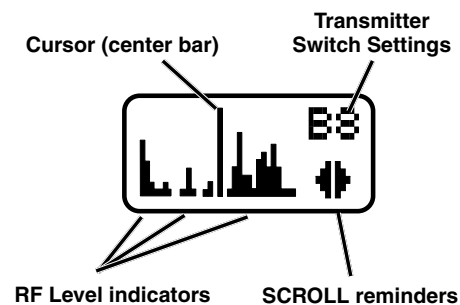

To use the integrated scanning function, press both SEL Up/Down buttons and the MENU button at the same time. The display will switch to the SCAN WINDOW and start scanning immediately. Data gathered during a scan is stored until it is purposely erased or the power is turned off. Previous data will remain and subsequent scans can be made to search for additional signals or to accumulate higher peaks.

To stop scanning, press the MENU button once. The scanning will stop immediately, and the display will switch to the VIEW window. In this window, each vertical band of the display represents 8 frequencies (800 kHz). Pressing the SEL Up or Down buttons will scroll the cursor coarsely across the tuning range. The transmitter switch settings matching the frequency indicated by the cursor are shown in the upper right corner of the screen.

Spectrum data is collected only when the receiver is scanning. Successive scanning with repeated passes through the tuning range will accumulate the highest peaks encountered to aid in finding clear frequencies. To clear the scan memory without leaving scan mode, turn the power switch off and back on quickly.

Pressing the MENU button once again will shift the display to the FINE VIEW window which shows an expanded portion of the spectrum around the cursor.

In the FINE VIEW window, each vertical band represents one frequency the UCR401 is capable of tuning. The upper right corner shows the transmitter switch settings for the frequency indicated by the cursor. In this

screen, a vertical center bar is the cursor. Underneath the switch settings are two arrows to remind you that this is a partial picture of the spectrum and that you can scroll left or right to view the entire spectrum of the receiver by pressing the SEL Up and Down buttons.

Pressing the SEL Up button will make the display scroll left, showing higher frequencies. Pressing the SEL Down button will make the display scroll right, showing lower frequencies. The cursor remains in place while the display scrolls left or right

The scanning mode is used to find a clear operating frequency. Scroll through the screen and find a frequency where no RF signals (or in the worst case, only very weak RF signals) are present. With the cursor on this frequency, simultaneously press the SEL Up, Down and MENU buttons to leave the scan mode.

When leaving the scan mode, you are given the option of using the frequency the unit was on before entering the scan mode, or using the frequency just selected in the scan mode. The display shows USE OLD and USE NEW to prompt you to make a frequency selection. To accept the new frequency just selected in the scan mode, press the SEL Down button for USE NEW. To return to the frequency you were using before entering the scan mode, press the SEL Up button for USE OLD. (The MENU button defaults to USE OLD.)

Once you leave the scan mode, the Frequency Window will be displayed. Set your transmitter switches to the same settings as shown on the display and your system will be ready for operation.

Antenna Orientation

Two antennas are used in a polarity switching, combining technique called **Smart Diversity™** to provide an immunity to dropouts caused by RF multipath reflections. Signals from the transmitter and from reflections arrive in a direct path from the transmitter and from reflections from other directions. To make full use of diversity reception, the antenna whips need to be spaced apart.

The whips are made of woven stainless steel and can be bent and shaped without damaging them. Shape them so they curve slightly away from each other for best reception.

In the diagrams below, the antenna patterns are simplified to help illustrate the effects of different orientations. Receiver antennas are most sensitive perpendicular to the whip, and transmitter antennas radiate maximum power perpendicular to the whip. Reflected signals that occur in normal use can also be useful, but they are not easy to predict and generally not reliable.

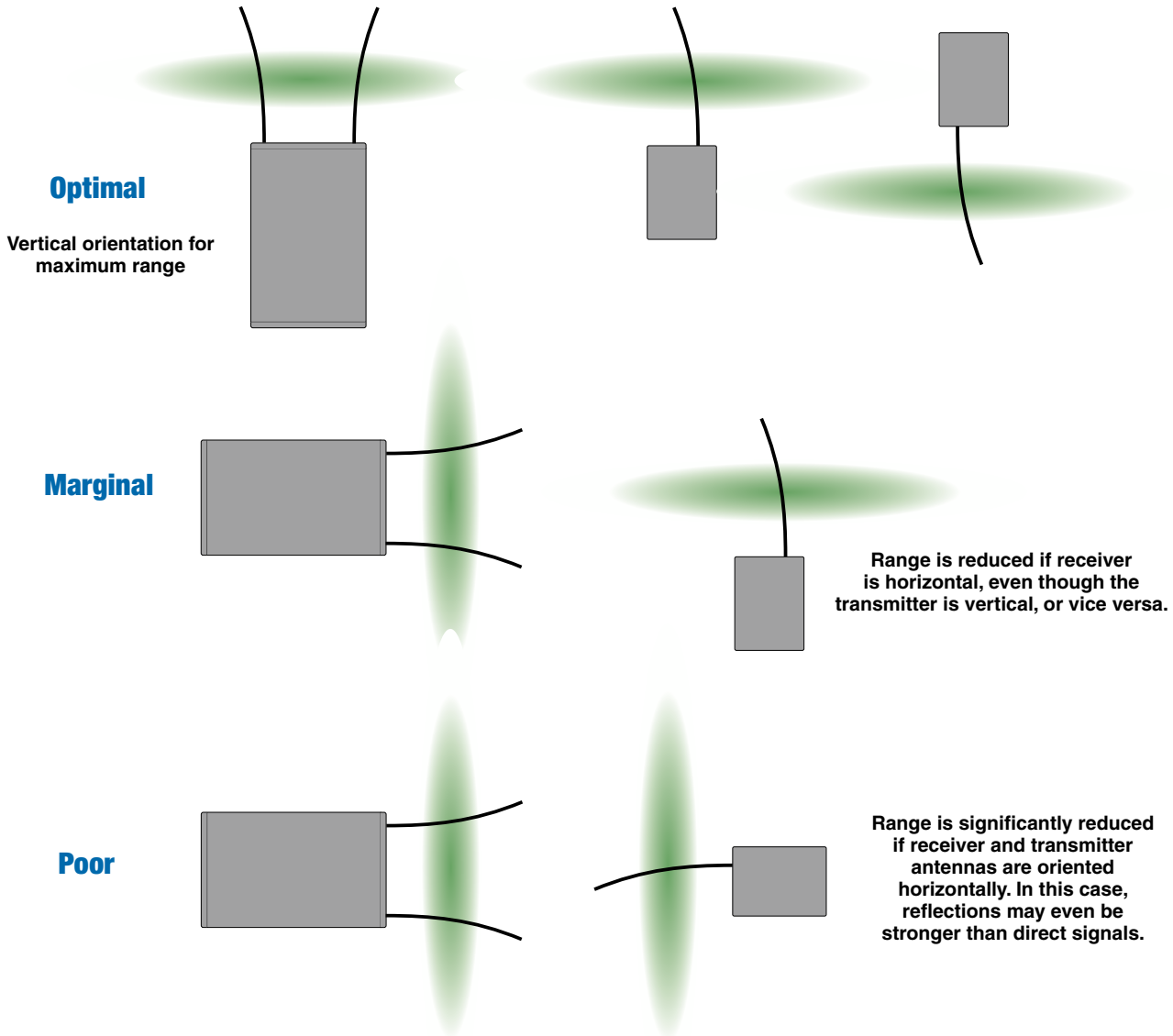
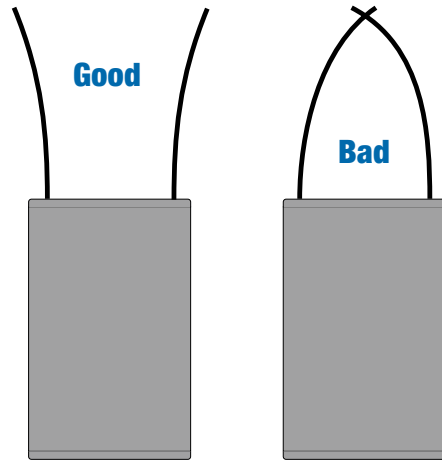

Setup and Operating Instructions

Installing/Replacing Batteries

1. As per the instructions engraved on the Battery Door, use your thumb to lift and open door. Then rotate it until it is perpendicular with the case.
2. Replace the old batteries, ensuring that you observe the polarity of the batteries when installing the new ones.



Battery Door

Battery polarity is shown on the side of the housing



Observe Battery Polarity



3. When finished rotate the door closed. You will feel it snap into place when it is fully closed.

Adjusting Audio Output

1. Install fresh batteries or connect an external power source to the UCR401.
2. Unless frequency settings have been previously assigned, scan for an open frequency and set both the receiver and transmitter to that frequency. (See Finding Clear Frequencies.)
3. Connect the audio cable to the receiver's Audio Out XLR jack.



AUDIO OUT XLR Jack

4. Set the Power ON/OFF switch to ON and verify that the LCD panel activates.



Power ON/OFF Switch

5. Adjust the transmitter gain. Refer to your transmitter manual's Operating Instructions section for details on how to adjust the transmitter gain. In general, adjust the transmitter gain so that the voice peaks will cause the audio modulation indicators on the receiver and transmitter to show full modulation on the loudest peak audio levels. Normal levels should cause the UCR401's audio level icon to fluctuate fully. This will result in the best possible signal to noise ratio for the system.

Warning: A common mistake is to use the transmitter audio gain control to set the overall audio level of the recorder or sound system. The transmitter gain control is only used to set the proper modulation of the transmitter to match the microphone placement and talker's voice level. Once set it should remain untouched until the microphone, placement or talker changes.

- Adjust the Audio Output on the receiver for an optimal level for your recorder or sound system. Use the LEVEL setup screen and adjust the level with the SEL Up and Down buttons.

The input levels of different cameras, VCRs, and PA equipment vary, which may require that you adjust the AUDIO OUT to an intermediate position. Try different settings and listen to the results. If the output of the receiver is too high, you may hear distortion or a loss of the natural dynamics of the audio signal. If the output is too low, you may hear steady noise (hiss) along with the audio. The UCR401 audio output is designed to drive any audio input device from microphone level to +5dBu line level.

Note: The test tone output is especially useful for an exact level match. With the test tone running, adjust for the maximum desired peak level using the metering on the connected device.

Finding Clear Frequencies

The following procedure will help you identify RF signals in the area and find clear channels for operating the wireless system.

- Ensure transmitter has fresh batteries and is turned off. Turn on the receiver and wait a few seconds until the Main Window appears on the LCD.
- Simultaneously press the MENU and SEL Up and Down buttons to enter Scan Mode.
- View the LCD while the receiver is scanning. The vertical marker will move across the display from left to right. RF activity will be indicated by black areas in the display.
- RF signal strength is indicated by markings in microvolts on the front panel to the left of the LCD. Look for clear channels in the spectrum where



SEL Up Button
SEL Down Button MENU Button

Press all three buttons at the same time and the receiver will start scanning.

there is no RF activity. Scanning will repeat and continue until the MENU button is pressed.

- If necessary, press the MENU button to zoom in for greater detail.
- Then press the SEL Up and Down buttons to move the marker to the middle of a clear area where there is no RF activity. If an area with no RF activity cannot be found anywhere in the spectrum, locate one with the least amount of RF activity.

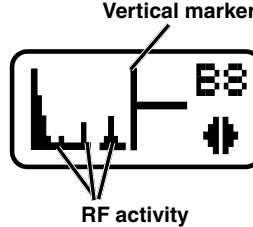

Strength of RF activity is indicated in microvolts with markings on the front panel

- Press all three buttons (SEL Up and Down and MENU) to move to the next screen. Two options will

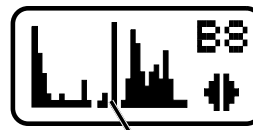
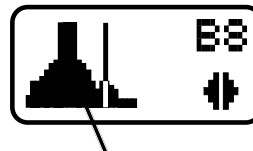

be shown.

Press the SEL Down arrow button to select the USE NEW option and set the receiver to the new frequency just found in scanning.

-OR-

Press the SEL Up arrow button to select USE OLD and return to the frequency that was set before scanning.

Press all three buttons at the same time to move to Frequency Select Screen

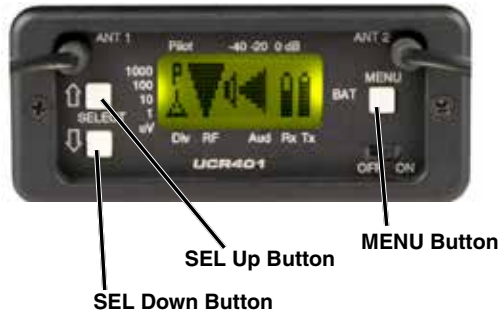

Locking and Unlocking the UCR401

Front Panel Controls

The front panel controls can be “LOCKED” to prevent accidental changes being made during operation and handling.

Note: Whether locked or unlocked, the setting persists when the unit is off and also when the batteries are removed.

To LOCK the UCR401

Press and hold the MENU button until a bar tracks horizontally across the LCD screen and the word “LOCKED” appears. If the MENU button is released before the word “LOCKED” appears, the unit will remain UNLOCKED.

In LOCKED state, the use of the MENU and SEL Up/Down buttons are limited to “view only” and any attempts to change selections will result in a LCD screen displaying the word “LOCKED.” The unit cannot be used for RF scanning when it is set in the LOCKED state. When in a LOCKED state, the pilot tone bypass toggle is also defeated.

To UNLOCK the UCR401

Press and hold the MENU button until a bar tracks horizontally across the screen and the word “UNLOCKED” is displayed on the LCD screen. When the unit is UNLOCKED, all settings can be altered.

The UCR401 can only be LOCKED or UNLOCKED from any of the main windows. (There are four of them.) Also, it cannot be switched between LOCKED and UNLOCKED modes when it is in a scanning mode or from other subordinate screens.



Pre-coordinated Frequencies

Interference from IM (intermodulation) is a potential problem in all multi-channel wireless systems, so proper frequency coordination is always required to avoid noise, range and dropout problems. Your options to accomplish this include:

- Using the pre-coordinated frequency groups
- Performing a system checkout
(See Multi-channel System Checkout)
- Contacting Lectrosonics for assistance

Groupings of compatible frequencies have been created to minimize intermodulation problems in multiple channel wireless systems. The frequencies can be used with Digital Hybrid and analog Lectrosonics wireless equipment. Compatibility with other brands is likely, but not guaranteed by Lectrosonics.

These frequencies have been calculated to minimize IM between these frequencies only. RF signals from outside sources can still interfere with operation, so even if only these pre-coordinated frequencies are being used, a Multi-channel System Checkout is still necessary. See the procedure on the next page.

Compatibility follows the pattern illustrated in the diagram at right.

Grp a and **Grp b** contain the 16 frequencies shown in the table below (upper orange/white set).

Grp c and **Grp d** contain the 16 frequencies shown in the table below (lower blue/white set).

NOTE: There is no assurance that frequencies are compatible between the upper orange/white set and the lower blue/white set. Combined use of frequencies from both sets requires testing with the procedures outlined in the following section entitled Multi-channel System Checkout

These frequencies share RF spectrum with TV channels. TV station broadcast signals are much more powerful than a wireless microphone transmitter, and can easily mix with the signals from the wireless system to produce a variety of interference problems. Even if these pre-coordinated frequencies are being used, it is always a good idea to go through the checkout procedure on the following page.

Active TV station and other external signals can be discovered by scanning with the receiver.

BLOCK 22

FREQ	SW SET	US TV CH
563.700	0,5	tv29
564.300	0,B	tv29
565.200	1,4	tv29
565.800	1,A	tv29
567.100	2,7	tv30
568.000	3,0	tv30
568.500	3,5	tv30
569.300	3,D	tv30
575.700	7,D	tv31
577.900	9,3	tv31
578.600	9,A	tv32
579.900	A,7	tv32
581.700	B,9	tv32
582.600	C,2	tv32
585.200	D,C	tv33
587.500	F,3	tv33

Grp a

BLOCK 22

FREQ	SW SET	US TV CH
570.100	4,5	tv30
570.700	4,B	tv30
571.600	5,4	tv30
572.200	5,A	tv31
573.200	6,4	tv31
574.400	7,0	tv31
574.900	7,5	tv31
575.500	7,B	tv31
581.100	B,3	tv32
582.100	B,D	tv32
582.600	C,2	tv32
584.300	D,3	tv32
585.000	D,A	tv32
585.600	E,0	tv32
586.300	E,7	tv32
588.100	F,9	tv32

Grp b

Pre-coordinated frequencies are arranged in four groups as shown at right.

The uppermost eight frequencies comprise Grp a, the eight just below them comprise Grp b, and so on.

BLOCK 24

FREQ	SW SET	US TV CH
621.300	4,5	tv39
621.900	4,B	tv39
622.800	5,4	tv39
623.400	5,A	tv39
624.400	6,4	tv39
625.800	7,0	tv39
626.100	7,5	tv40
626.700	7,B	tv40
632.300	B,3	tv41
633.300	B,D	tv41
633.800	C,2	tv41
635.500	D,3	tv41
636.200	D,A	tv41
636.800	E,0	tv41
637.500	E,7	tv41
639.300	F,9	tv42

Grp c

BLOCK 25

FREQ	SW SET	US TV CH
646.900	4,5	tv43
647.500	4,B	tv43
648.400	5,4	tv43
649.000	5,A	tv43
650.000	6,4	tv43/44
651.200	7,0	tv44
651.700	7,5	tv44
652.300	7,B	tv44
657.900	B,3	tv45
658.900	B,D	tv45
659.400	C,2	tv45
661.100	D,3	tv45
661.800	D,A	tv45
662.400	E,0	tv46
663.100	E,7	tv46
664.900	F,9	tv46

Grp d

Displayed as "GROUP a" through "GROUP d" in the LCD and as "Grp a" through "Grp d" in VRpanel

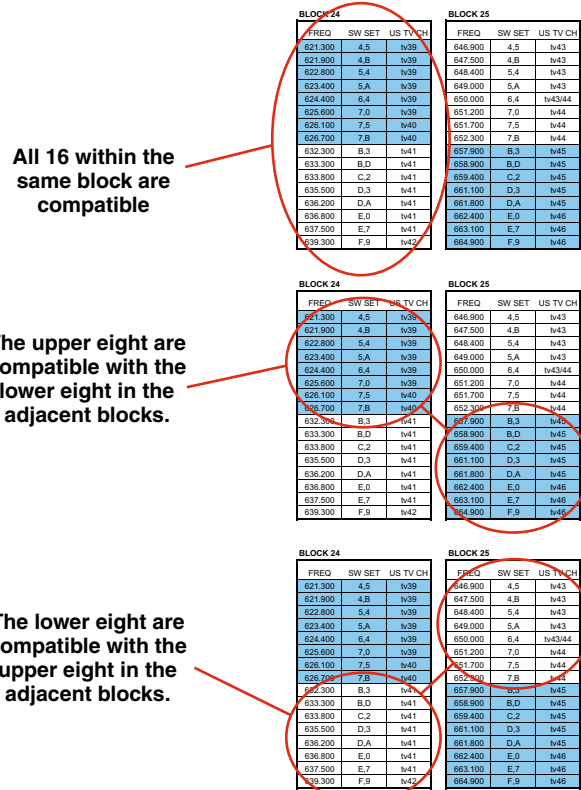

Frequency Coordination

IM (intermodulation) is a process of two or more RF signals mixing in any stage in the transmitter or receiver that generates another RF signal. If this new signal happens to land on a carrier, IF or oscillator frequency you may have interference problems that affect range or audio quality. The possible combinations also include odd and even order harmonics of the carriers.

Feel free to contact the factory if you need help in coordinating frequencies. A specialized computer program is used to perform thousands of calculations and identify various interfering signals. Potential problems and trouble areas can be identified in advance, and proposed new frequencies or other solutions can be suggested. This service is offered to authorized Lectrosonics dealers and other customers who are using Lectrosonics® wireless microphone and wireless IFB systems.

Even with thorough analysis, interference can still be present from local sources that cannot be predicted in advance. This makes it mandatory to check out a multi-channel system before the production or use begins.

Multi-channel System Checkout

Intermodulation (IM) and crosstalk **increases** as the distance between transmitters and receiver **decreases**. In order to conduct a valid checkout of multi-channel compatibility using the procedure shown here, it is best to adhere to the following guidelines:

- 4 to 5 feet between transmitters
- 20 to 25 feet between transmitters and receiver antennas
- Receiver antennas not touching one another

If the distances are **less** than this, IM will be exaggerated and not likely to be realistic. If the distances are **greater** than this, IM products that could occur during actual use that may not show up in the checkout procedure.

Interference can result from a wide variety of sources including TV station signals, other wireless equipment in use nearby, or from intermodulation within a multi-channel wireless system itself.

The pre-coordinated frequencies in the tables on the previous pages address in-system compatibility, but obviously do not take into account RF signals from external sources that may be present in the location where the system will be operating.

The scanning process will identify external RF signals, but it does not address the compatibility of the selected frequencies. Always go through the following steps to make sure the frequencies that are chosen are compatible within themselves and also free from external interference.

1. **Set up the system for testing.** Place antennas in the position they will be used and connect to the receivers. Place transmitters about 4 to 5 feet apart and about 20 to 25 feet from the receiver antennas. If possible, have all other equipment on the set, stage or location turned on as well, especially any mixing or recording equipment that will be used with the wireless system.
2. **Turn on all receivers. Leave transmitters off.** Look at the RF level display on each receiver. If an indication is present, change the frequency to a clear channel where no signal is indicated. If a completely clear channel cannot be found, set it for the one with the lowest RF level indication. Once all receivers are on clear channels, go to the next step.
3. **Start with all transmitters turned off.** Then turn on one transmitter at a time. Look at the matching receiver to verify a strong RF signal is received. Then, look at the other receivers and see if one of them is also picking up the signal. Only the matching receiver should indicate a signal. Change frequencies on either system slightly until it will pass this test, then check again to see that all receivers are still on clear channels as in Step 2. Repeat this procedure for each transmitter, one at a time.
4. **With all transmitters and receivers turned on, turn each transmitter OFF one at a time.** Look at the RF level indicator on the receiver that matches the transmitter that is turned off. It should “fall silent” and the RF level should disappear or drop to a very low level. If it does not, change the frequency on that receiver and transmitter and try it again.

IMPORTANT: Any time a frequency is changed on any of the systems in use, you must start at the beginning and go through this procedure again for all systems. With a little practice, you will be able to do this quickly and save yourself some grief.

Pilot Tone Bypass

Some wireless equipment uses a supersonic “pilot tone” to control the squelch (audio mute) of a receiver module to keep it silent until a valid signal is received. When a signal with the correct pilot tone is received, the squelch opens and audio is delivered to the output. Pilot tone squelch control also eliminates transients (clicks and pops) when transmitters are turned on and off. Pilot tone is supported in the Digital Hybrid compatibility modes for those systems that use it.

Pilot tone control can be bypassed as a diagnostic tool. Bypass opens the audio output of the receiver unconditionally, allowing you to listen to any signals entering the receiver to help identify their source. Pilot tone bypass will also allow you to use a transmitter that has a defective pilot tone circuit.

CAUTION: When pilot tone is bypassed and the transmitter is turned off, excessive noise will be present. Turn the audio level down before bypassing pilot tone.

Replacement Parts and Accessories

CCMINI

Zippered, padded vinyl system pouch

DCR12/A4U

Power Supply; 90-240 VAC, 50/60 Hz input; 12 VDC (regulated), 400 mA max. output.

VSR1

Thin velcro loop for power cable strain relief.

PS70

A/C power supply with 3-pin NEMA socket on housing, 100-240 VAC input; 13.8 VDC, 2.8 A (max.) output.

21425

6 ft. long power cord; coaxial to stripped & tinned leads. Coaxial plug: ID-.080"; OD-.218"; Depth-.5". Fits all compact receiver models that use CH12 power supply.

21472

6 ft. long power cord; coaxial to stripped & tinned leads. Right angle coaxial plug: ID-.075"; OD-.218"; Depth-.375". Fits all compact receiver models that use CH12 power supply.

CCMINI



DCR12/A4U



VSR1



PS70



Mating power plug dimensions

21425

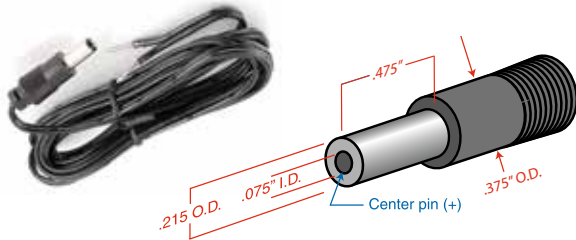

VSR1



PS70



21472

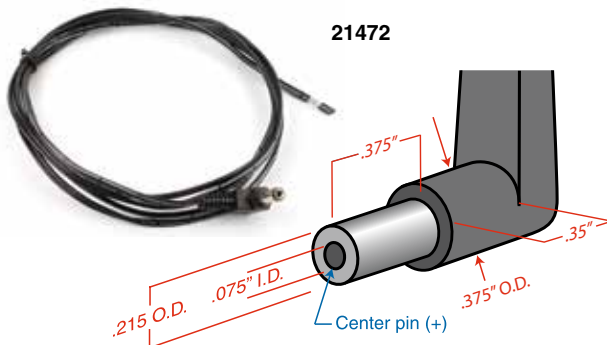

Troubleshooting

Symptom	Possible Cause
INITIAL POWER ON	
LCD display not active or lit	<p>External power supply disconnected or inadequate.</p> <p>Wrong polarity power source. The external power input jack requires POSITIVE (+) to be on the center pin. Battery gets warm and doesn't work.</p> <p>Battery may be low. Try fresh batteries.</p>
Version message shows DSP or COM	This indicates an internal error. Please contact the factory for assistance.
Display indicates CHECK FREQ	<p>This is a warning that a strong RF signal is present that is not centered on the channel, and the audio is likely to be distorted.</p> <p>There are three principal causes:</p> <ol style="list-style-type: none"> 1) The transmitter is set to the wrong channel, but close to the the correct channel. Check frequency setting of transmitter. 2) A foreign signal is causing the condition, such as from a local TV station or from intermodulation from another transmitter. Retune the receiver and transmitter to a clear frequency. 3) The transmitter carrier frequency is not correct (rare occurrence). Contact factory for repair. <p>If any of these solutions don't remove the warning message, the transmitter or receiver may need repair.</p>
PILOT TONE SQUELCH	
Pilot Tone indicator (P) present, but no sound (Check audio meter first)	<p>Audio output cable bad or disconnected.</p> <p>Audio Output level too low. Use the built-in test tone to verify levels.</p>
Pilot Tone Indicator (P) keeps flashing when transmitter turned on	<p>Pilot tone detection can take several seconds. Turn on the transmitter power (and the audio switch on some models) and wait 3 to 5 seconds for the "P" to indicate steadily.</p> <p>Transmitter and receiver not on same frequency.</p> <p>Receiver compatibility mode does not match the transmitter in use. (See Menu Selections from Main Window, COMPAT Window.)</p>
Noise on audio and Pilot Tone Indicator is "b"	The pilot tone bypass has been activated. Hold MENU and press UP to reset (works only from the Main Window).
Pilot Tone Indicator not present but receiving audio	Receiver is set to a compatibility mode that doesn't use Pilot Tone. Check that receiver compatibility mode matches the transmitter in use as any sufficiently strong signal can unquench the receiver in this mode, compatible or not.

NOTE: In the 400 Series, 200 Series and Mode 6 compatibility modes, the PILOT indicator on the front panel shows as a solid "P" to indicate that the audio has been turned on at the transmitter, and that the audio output on the receiver is enabled. When the "P" is on, the audio is enabled. If the "P" is flashing the pilot tone is not detected and the audio will be muted (squelched).

In the other compatibility modes, no pilot tone is used and the "P" is never displayed. Audio is present whenever the receiver detects a sufficiently strong signal.

Regardless of the compatibility mode, activating the "pilot bypass" function causes a lowercase "b" to appear in the pilot indicator position on the main window and forcibly unquench the audio.

Symptom**Possible Cause****ANTENNAS AND RF SIGNAL STRENGTH****RF Level is weak**

Receiver may need to be moved or reoriented.

Antenna on transmitter or receiver may be defective or poorly connected - double check antennas.

Improper length of antenna, or wrong antenna on transmitter or receiver. UHF whip antennas are generally about 3 to 5 inches long. UHF helical antennas may be shorter, but are often less efficient.

No RF Signal

Make certain frequency switches on transmitter match the receiver frequency setting.

Check battery in transmitter.

AUDIO SIGNAL QUALITY**Poor signal to noise ratio**

Transmitter gain set too low.

The noise may not be in the wireless system. Turn the transmitter audio gain all the way down and see if the noise remains. If the noise remains, then turn the power off at the transmitter and see if it remains. If the noise is still present, then the problem is not in the transmitter.

If noise is still present when the transmitter is turned off, try lowering the audio output level on the UCR401 and see if the noise lowers correspondingly. If the noise remains, the problem is not in the receiver.

Receiver output is too low for the input of the device it is feeding. Try increasing the output level of the UCR401 and lowering the input gain on the device the UCR401 is feeding.

Distortion

Transmitter input gain too high. Check and/or readjust input gain on transmitter according to the LEDs on the transmitter and then verify the setting with the audio meter in the main window.

Audio output level too high for the device the UCR401 is feeding. Lower the output level of the UCR401.

Bad frequency response or generally poor audio quality

Ensure the receiver is set to the compatibility mode that matches the transmitter in use.

Specifications and Features

Operating Frequencies (MHz):

Block 470:	470.100 - 495.600
Block 19:	486.400 - 511.900
Block 20:	512.000 - 537.500
Block 21:	537.600 - 563.100
Block 22:	563.200 - 588.700
Block 23:	588.800 - 607.900 and 614.100 - 614.300
Block 24:	614.400 - 639.900
Block 25:	640.000 - 665.500
Block 26:	665.600 - 691.100
Block 27:	691.200 - 716.700
Block 28:	716.800 - 742.300
Block 29:	742.400 - 767.900
Block 944:	944.100 - 951.900

Frequency Adjustment Range: 25.5 MHz in 100kHz steps

Channel Separation: 100 kHz

Receiver Type: Triple conversion, superheterodyne, 244 MHz, 10.7 MHz and 300 kHz

Frequency Stability: ±0.001 %

Front end bandwidth: 30 MHz @ -3 dB

Sensitivity

20 dB Sinad: 1 µV (-107 dBm), A weighted

60 dB Quieting: 1.5 µV (-104 dBm), A weighted

Squelch quieting: Greater than 100 dB

AM rejection: Greater than 60 dB, 2 µV to 1 Volt (Undetectable after processing)

Modulation acceptance: 85 kHz

Image and spurious rejection: 85 dB

Third order intercept: +0 dBm

Diversity method: SmartDiversity™ phased antenna combining

FM Detector: Digital Pulse Counting Detector operating at 300 kHz

Antenna inputs: Two, fixed whip

Audio outputs

Rear Panel XLR: Adjustable from -50dBu to +5dBu in 1 dB steps. Calibrated into a typical 10 k Ohm balanced load. Can drive 600 Ohm load.

Front Panel Controls and Indicators:

LCD control panel Main window: Pilot tone; antenna phase, receiver battery level; transmitter battery status; audio level, RF level

Frequency window: Frequency, TV channel;

Transmitter switch setting

Audio output level adjustment: -50 dBu to +5 dBu

Battery level tracking: Receiver (AA battery) in 1/10th volt steps, accuracy +/- 0.2V.

Transmitter (AA battery) x.xxV format, accuracy +/- 0.1V.

Timer option available when NiMH used.

Scanning mode: Coarse and fine modes for RF spectrum site scanning

Audio test tone: 1 kHz, -50 dBu to +5 dBu output, 1% THD

Transmitter battery type selection: 9V alkaline, 9V lithium, AA alkaline, AA lithium, NiMH

Phase invert: Audio output phase normal or inverted

SmartNR (noise reduction): OFF, NORMAL, FULL modes (available in 400 Series mode only)

Audio Performance (overall system): (These specs apply to 400 Series mode only.)

Frequency Response: 32 Hz to 20 kHz (+/- 1dB)

THD: 0.2% (typical)

Signal to Noise Ratio (dB):
(overall system, 400 Series mode)

SmartNR	No Limiting	w/Limiting
OFF	103.5	108.0
NORMAL	107.0	111.5
FULL	108.5	113.0

Note: The dual envelope "soft" limiter provides exceptionally good handling of transients using variable attack and release time constants. Once activated, the limiter compresses 30+ dB of transmitter input range into 4.5 dB of receiver output range, thus reducing the measured figure for SNR without limiting by 4.5 dB

Total Harmonic Distortion: 0.2% typical (400 Series mode)

Input Dynamic Range: 125 dB (with full Tx limiting)

Rear Panel Controls and features:

XLR audio output jack;
External DC input;
Battery compartment access

Power Options:

Ext DC: Minimum 6 Volts to maximum 18 Volts DC;

150 mA at 6 VDC; 75 mA at 18 VDC

Int Batt: Two AA 1.5 Volt alkaline, lithium or NiMH (270 mA @ 3V)

Battery Life:

AA alkaline 4 hours continuous

AA NiMH 8 hours (2500 mA)H

AA lithium Up to 21 hours (continuous and intermittent usage are the same)

Weight: 13 oz. with batteries

Dimensions: 2.83" wide x 1.25" high x 4.64" deep
(2.83 mm x 32 mm x 118 mm)

Specifications subject to change without notice

Service and Repair

If your system malfunctions, you should attempt to correct or isolate the trouble before concluding that the equipment needs repair. Make sure you have followed the setup procedure and operating instructions. Check the interconnecting cables and then go through the **Troubleshooting** section in this manual.

We strongly recommend that you **do not** try to repair the equipment yourself and **do not** have the local repair shop attempt anything other than the simplest repair. If the repair is more complicated than a broken wire or loose connection, send the unit to the factory for repair and service. Don't attempt to adjust any controls inside the units. Once set at the factory, the various controls and trimmers do not drift with age or vibration and never require readjustment. **There are no adjustments inside that will make a malfunctioning unit start working.**

LECTROSONICS' Service Department is equipped and staffed to quickly repair your equipment. In warranty repairs are made at no charge in accordance with the terms of the warranty. Out-of-warranty repairs are charged at a modest flat rate plus parts and shipping. Since it takes almost as much time and effort to determine what is wrong as it does to make the repair, there is a charge for an exact quotation. We will be happy to quote approximate charges by phone for out-of-warranty repairs.

Returning Units for Repair

For timely service, please follow the steps below:

- A. DO NOT return equipment to the factory for repair without first contacting us by email or by phone. We need to know the nature of the problem, the model number and the serial number of the equipment. We also need a phone number where you can be reached 8 A.M. to 4 P.M. (U.S. Mountain Standard Time).
- B. After receiving your request, we will issue you a return authorization number (R.A.). This number will help speed your repair through our receiving and repair departments. The return authorization number must be clearly shown on the **outside** of the shipping container.
- C. Pack the equipment carefully and ship to us, shipping costs prepaid. If necessary, we can provide you with the proper packing materials. UPS is usually the best way to ship the units. Heavy units should be "double-boxed" for safe transport.
- D. We also strongly recommend that you insure the equipment, since we cannot be responsible for loss of or damage to equipment that you ship. Of course, we insure the equipment when we ship it back to you.

Lectrosonics USA:

Mailing address:

Lectrosonics, Inc.
PO Box 15900
Rio Rancho, NM 87174
USA

Shipping address:

Lectrosonics, Inc.
581 Laser Rd.
Rio Rancho, NM 87124
USA

Telephone:

(505) 892-4501
(800) 821-1121 Toll-free
(505) 892-6243 Fax

Web:

www.lectrosonics.com

E-mail:

sales@lectrosonics.com

Lectrosonics Canada:

Mailing Address:

720 Spadina Avenue,
Suite 600
Toronto, Ontario M5S 2T9

Telephone:

(416) 596-2202
(877) 753-2876 Toll-free
(877-7LECTRO)
(416) 596-6648 Fax

E-mail:

Sales: colinb@lectrosonics.com
Service: joeb@lectrosonics.com

LIMITED ONE YEAR WARRANTY

The equipment is warranted for one year from date of purchase against defects in materials or workmanship provided it was purchased from an authorized dealer. This warranty does not cover equipment which has been abused or damaged by careless handling or shipping. This warranty does not apply to used or demonstrator equipment.

Should any defect develop, Lectrosonics, Inc. will, at our option, repair or replace any defective parts without charge for either parts or labor. If Lectrosonics, Inc. cannot correct the defect in your equipment, it will be replaced at no charge with a similar new item. Lectrosonics, Inc. will pay for the cost of returning your equipment to you.

This warranty applies only to items returned to Lectrosonics, Inc. or an authorized dealer, shipping costs prepaid, within one year from the date of purchase.

This Limited Warranty is governed by the laws of the State of New Mexico. It states the entire liability of Lectrosonics Inc. and the entire remedy of the purchaser for any breach of warranty as outlined above. NEITHER LECTROSONICS, INC. NOR ANYONE INVOLVED IN THE PRODUCTION OR DELIVERY OF THE EQUIPMENT SHALL BE LIABLE FOR ANY INDIRECT, SPECIAL, PUNITIVE, CONSEQUENTIAL, OR INCIDENTAL DAMAGES ARISING OUT OF THE USE OR INABILITY TO USE THIS EQUIPMENT EVEN IF LECTROSONICS, INC. HAS BEEN ADVISED OF THE POSSIBILITY OF SUCH DAMAGES. IN NO EVENT SHALL THE LIABILITY OF LECTROSONICS, INC. EXCEED THE PURCHASE PRICE OF ANY DEFECTIVE EQUIPMENT.

This warranty gives you specific legal rights. You may have additional legal rights which vary from state to state.



581 Laser Road NE • Rio Rancho, NM 87124 USA • www.lectrosonics.com
+1(505) 892-4501 • fax +1(505) 892-6243 • (800) 821-1121 US and Canada • sales@lectrosonics.com