

# **CP4**

## **COMBINING AUTOMATIC PREAMP MODULE**

---

---

### **OPERATING INSTRUCTIONS and trouble-shooting guide**

---

---

**LECTROSONICS, INC.**  
Rio Rancho, NM

# INTRODUCTION

The CP4 Combining Automatic Mic Preamp Module provides balanced, low-noise pre-amplification of signals from microphone to line levels. The CP4 (in combination with an MC4 Matrix Combining Module) implements all necessary functions to perform room combining, for up to four rooms, using automatic mixing.

---

## TABLE OF CONTENTS

INTRODUCTION .....	1
GENERAL TECHNICAL DESCRIPTION .....	2
INSTALLATION .....	3
FRONT PANEL DESCRIPTION .....	3
REAR PANEL DESCRIPTION .....	4
OPERATING INSTRUCTIONS .....	5
TROUBLESHOOTING .....	7
SERVICE AND REPAIR .....	8
RETURNING UNITS FOR REPAIR .....	8
SPECIFICATIONS .....	9
APPENDIX 1 configuring the Logic Output .....	10
WARRANTY .....	Back cover

## GENERAL TECHNICAL DESCRIPTION

The microphone preamp of the CP4 uses a modern integrated preamplifier circuit for low equivalent input noise and low distortion. This preamp provides a convenient means for adjusting preamp gain to maximize signal-to-noise ratio for any microphone. This is in contrast to many automatic mixers which employ fixed gain microphone preamps.

A sophisticated gain proportional algorithm is employed in the CP4 to effect automatic mixing. The signal level at each channel is compared with an overall reference level (set by a mix of all channels in the system) to determine how much attenuation to apply.

Each channel can be assigned (through the use of dipswitches) to any one of the four room outputs. This allows the most flexible usage of the available microphone channels. Each channel has two operational modes, Auto and Direct, which are set via an internal jumper. In the Auto mode, the channel will open when there is signal present. In the Direct mode, the channel will always be open, regardless of the presence or absence of signal. The green LED Channel On indicator will glow in a manner proportional to the instantaneous channel gain. In the Direct mode, however, modulation of the Channel On LED should be interpreted as signal activity on that channel rather than channel gain, since the channel is always open in the Direct mode.

An internal jumper is also provided for Mic/Line input level capability. In the Mic position, the preamp gain ranges from 20dB to 65dB. In the Line position, the Input Trim control is disabled, and the microphone preamp gain is unity. Line input levels of up to +20dBu can be safely accommodated.

An optically coupled Logic Output is provided on a rear panel terminal strip to indicate when a channel is open. The output may be wired active high or active low, depending on the application (see Appendix 1 for electrical details). In addition, internal jumpers set the threshold for Logic Out activation. Levels of 2dB, 4dB, 6dB, and 8dB below unity gain (in the channel attenuator) can be set as necessary for the installation.

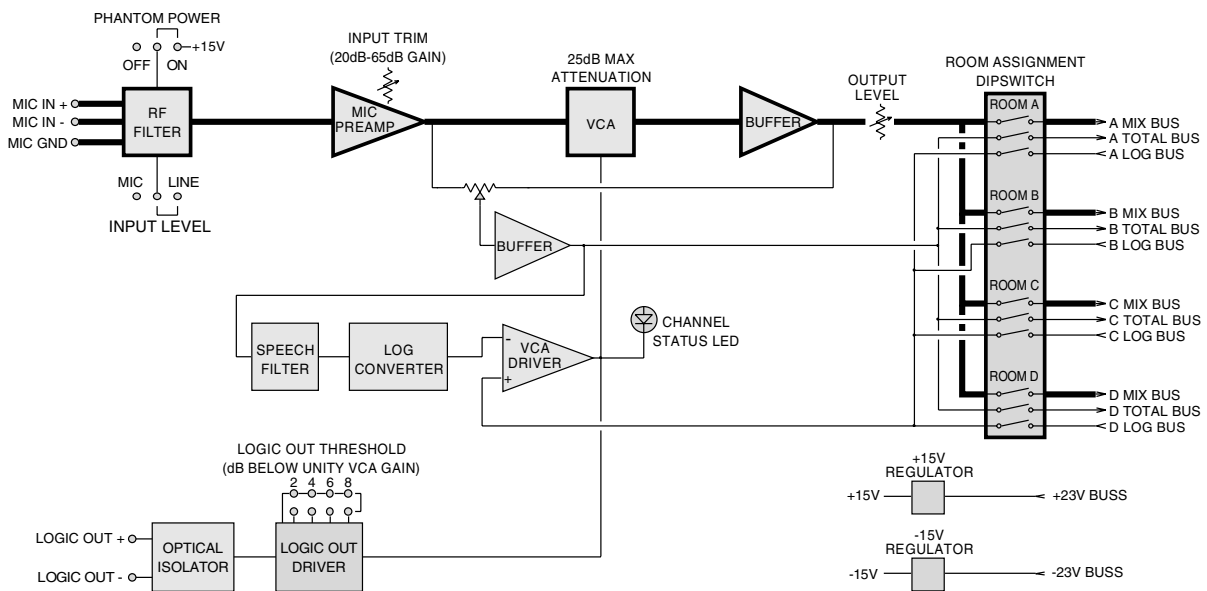

**Figure 1 - CP4 Block Diagram - One of Four Channels**

## INSTALLATION

Before installing the module, see the Operating Instructions section for guidance as to how to select the various jumperable options on the CP4.

The CP4 is installed from the rear of the Modular Audio Processor mainframe. The CP4 modules must be loaded from left to right (facing the rear of the mainframe), with the first CP4 in the slot adjacent the MC4. All the CP4s need to be in adjacent slots.

Care should be taken when aligning the circuit board with the card guides. Once the module is aligned, slide the card forward in the mainframe until the female edge connector on the module seats firmly onto the male pins of the main bus board. Again, care should be taken to insure proper mating of the connectors.

Four #4 machine screws are provided with the CP4 module. The two screws with captive washers are used to secure the rear panel to the top and bottom rails of the mainframe. After this is accomplished, fit the front panel (also supplied) over the front of the module and secure it, using the two flat-head #4 machine screws, to the front panel of the Modular Audio Processor mainframe. Once these four screws are in place, the installation is complete.

After mechanical installation, connect the first CP4 to the MC4 using the BUS EXPANSION jacks and the supplied ribbon cable then connect all the CP4s together with ribbon cables.

## FRONT PANEL DESCRIPTION

**INPUT TRIM** - Allows control of the microphone preamplifier gain from 20dB-65dB. Changing the Input Trim makes the microphone channel more (or less) sensitive to speech sounds relative to other system microphones. An internal Mic/Line jumper allows the gain structure on the CP4 to be optimized for either microphone or line level signals.

**OUTPUT LEVEL** - Allows control of the amount of signal sent to the room output bus. Adjustment of the output level control changes the system loudness of the microphone channel, but has no effect on the channel's relative sensitivity.

**CHAN ON LED** - This LED indicates the relative attenuation of the channel gain control element. The LED brightness modulates as the instantaneous channel gain change. The LED is brightest at minimum channel attenuation (i.e. channel fully open). The Channel On LED will indicate relative channel attenuation in the Auto mode, and relative signal level in the Direct mode.

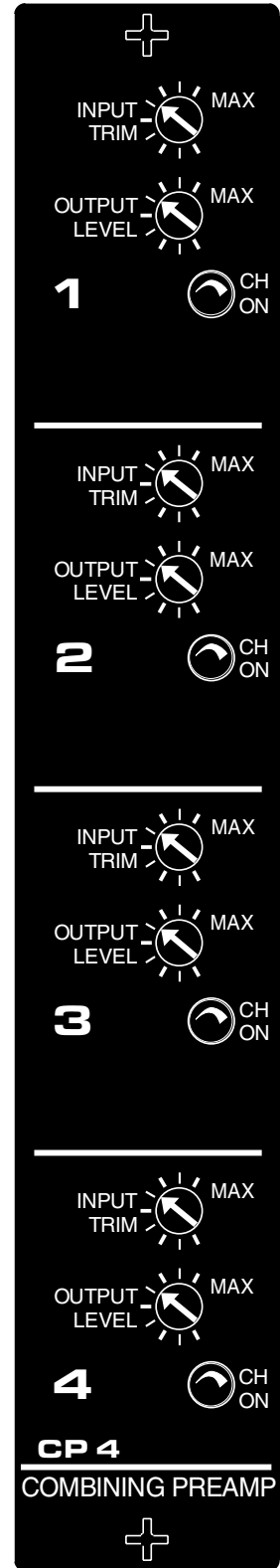

Figure 2  
CP4 Front Panel

# REAR PANEL DESCRIPTION

**BAL IN** - Provides an electronically balanced, RF protected input for use with either balanced or unbalanced microphones or line level inputs. Phantom power is jumper selectable on a per channel basis. Phantom power voltage is +15V, at a maximum of 12.5mA per input. A Mic/Line level jumper allows the CP4 to accommodate any signal source.

**LOGIC OUT** - Provides a logic signal that corresponds to channel "ON" status. Will actuate if the channel attenuation is less than or equal to the value set by the Logic Threshold jumpers (2dB, 4dB, 6dB or 8dB). The output is an optically isolated NPN transistor. The "+" output is connected to the collector of the transistor. The "-" output is connected to the emitter of the transistor. The device is compatible with normal 5 Volt power, and has a maximum breakdown voltage of 30 Volts. The output can be wired as active high or active low (see Appendix 1 for details).

**BUS EXPANSION IN/OUT** - This connector provides the necessary interconnection between the MC4 Controller and the CP4 Preamp(s). Be sure the first CP4 is connected to the MC4 and, if there are multiple CP4s, that they all are connected together via this jack.

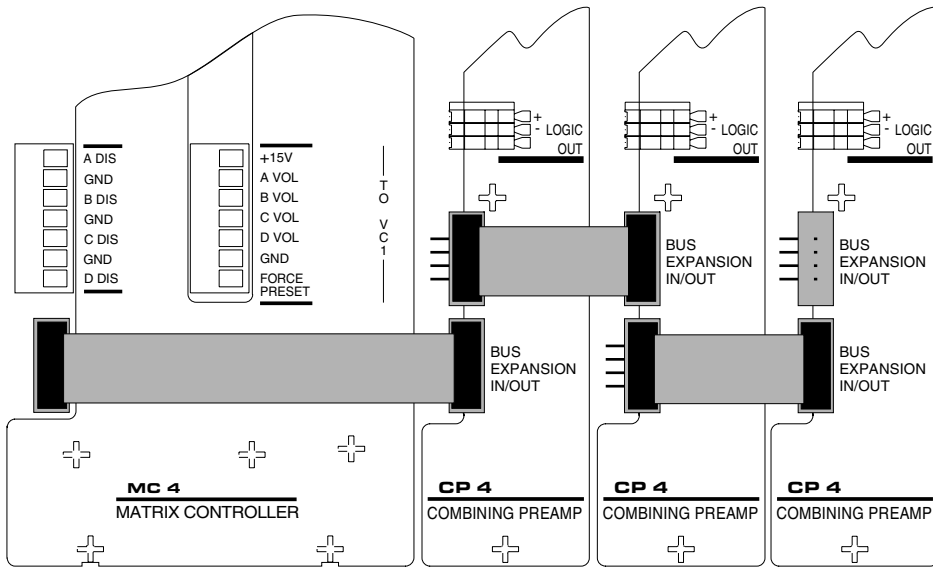

Figure 4 - Bus Expansion Cabling

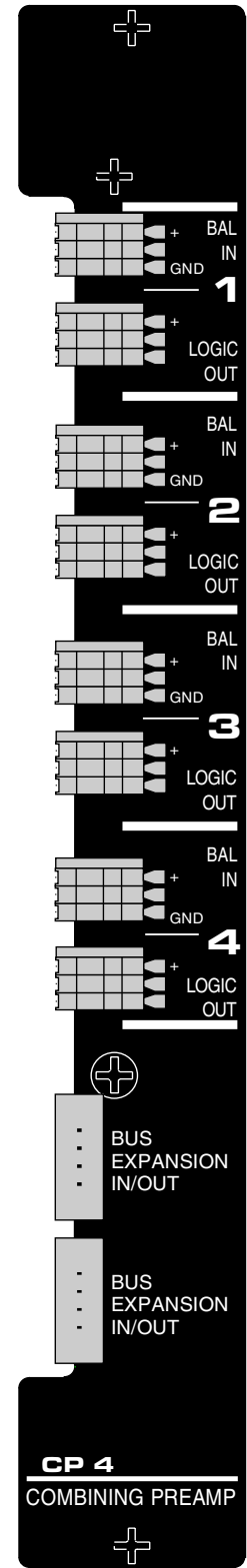
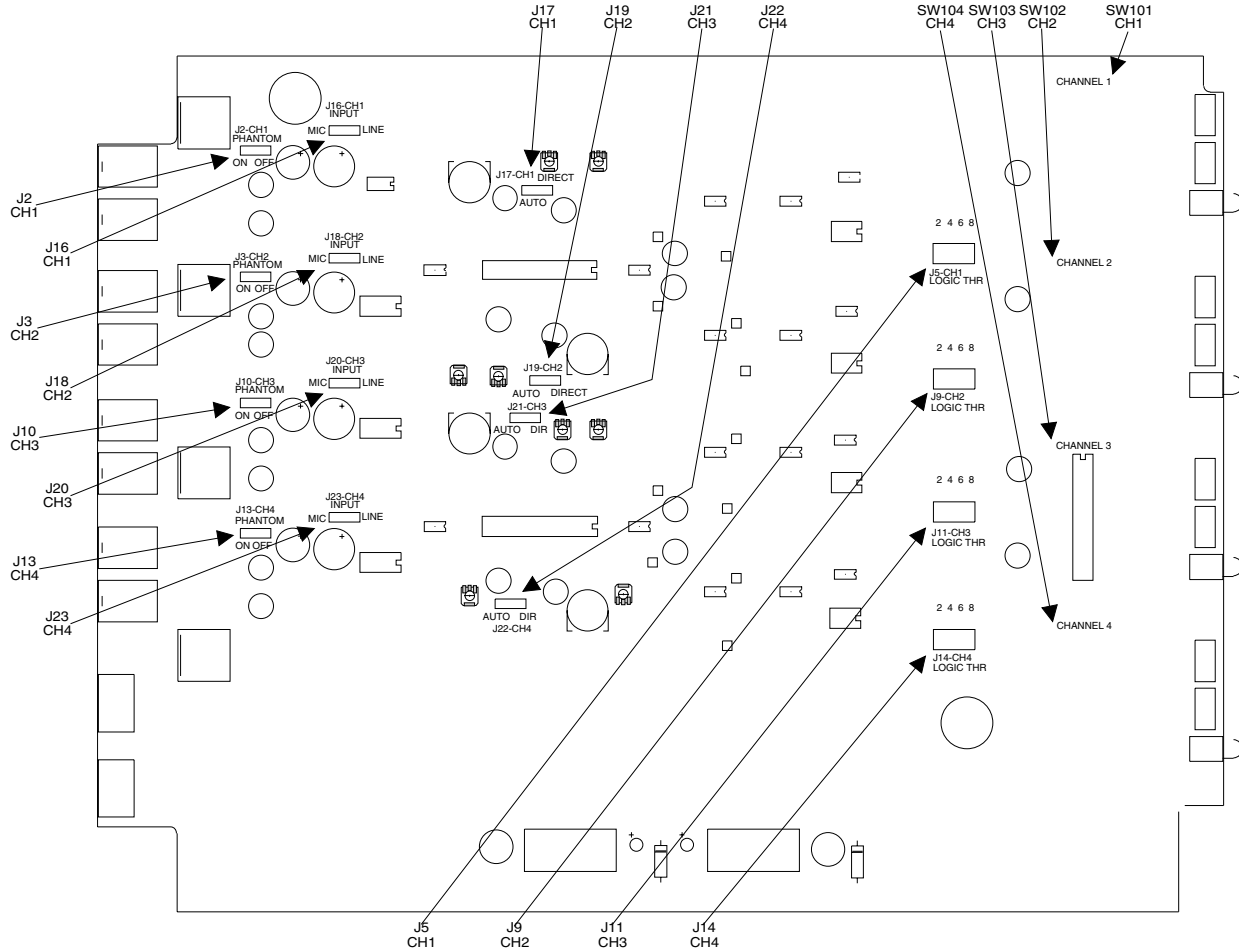

Figure 3  
CP4 Rear Panel

# OPERATING INSTRUCTIONS

The following instructions assume the presence of an MC4 Matrix Controller Module. Note that certain power-up settings on the MC4 must be accomplished before attempting system setup. The details of the MC4 setup are found in the MC4 instruction manual.



**Figure 5 - CP4 Jumper Locations**

- 1) Select the proper jumper settings for the application. Figure 4 shows the locations of all the jumpers and Figure 5 illustrates the factory settings of all the jumperable options, along with the jumper positions for each option. A short description of each jumperable option follows:

**Phantom Power** - Provides a means of applying +15V phantom power to the "+" and "-" microphone input terminals. A maximum of 12.5mA per terminal is available. Factory default is phantom power Off.

**Mic/Line** - Provides the means to accommodate either balanced microphone or line level signals. In the Mic position, the Input Trim control changes the preamplifier gain from 20dB to 65dB. In the Line position, the Input Trim control is disabled, and the preamplifier gain is unity (0dB).

**Auto/Direct** - Selects the channel operational mode. Auto mode is normal automatic operation. Direct mode is analogous to a manual mixer, with the channel open at all times, regardless of channel activity.

**Logic Threshold** - Provides a means of adjusting the actuation point of the Logic Output. The jumper values are 2dB, 4dB, 6dB, or 8dB of channel attenuation below unity. In general, the actuation level should be increased as the number of microphones in the system increases according to the table below:

Up to 4 mics:	2dB
5 to 8 mics:	4dB
9 to 16 mics:	6dB
17 or more:	8dB

- 2) After jumper selections are made, each channel must be assigned to one of the four room busses (i.e. Room A, B, C, or D). This is accomplished using the 12 position dipswitch associated with each channel (SW101, SW102, SW103, SW104.) It is necessary to switch 3 dipswitches of the 12 to assign the channel to a given room. The drawing below shows the 4 options and their associated dipswitch settings:

CP4 Configuration Jumpers				
Function	Channel			
	1	2	3	4
Phantom Power				
Mic / Line				
Auto / Direct				
Logic Threshold				
Channel to Room Assignment				

Figure 6 - CP4 Configuration Jumpers

- 3) A special setup mode may be initiated by shorting the Force Preset terminal on the MC4 Controller to ground and then turning on the AC power. This mode sets the internal electronic volume controls to maximum gain, and flashes the Power LED. In this manner, an overall maximum system gain may be set up which the user can never exceed when using the VC1 Remote Volume controls. In addition, both the Music and Page signal inputs are active in order to set up the desired level for these signals.
- 4) Set the Room Output level controls on the MC4 at about 10 o'clock. Set the Output Level controls on the CP4 channels to about 10 o'clock. For each microphone, speak in a normal voice into the microphone and adjust the Input Trim control until adequate system loudness is achieved. The Ch On LED should glow brightly during normal speech.
- 5) If the system is to have background music, turn on the music source and set the desired music volume using the Music level control on the rear of the MC4. Note that the MS In is a line level input, suitable for input from a tuner, tape player, or compact disc player.
- 6) If the system is to have paging capability, the paging signal source should be connected to the PG In on the rear of the MC4. The PG In is a balanced line level input. If the page attenuation function is to be used, the PG LG terminals must be shorted together (with either a mechanical or electrical closure) simultaneously with the paging announcement.
- 7) Once all microphones and auxiliary inputs have been set properly, turn the power off and on again, without shorting Force Preset to ground. The system will now function in the normal mode.

## TROUBLESHOOTING

SYMPTOM	POSSIBLE CAUSE
1) No sound from system	1) Main level control not turned up 2) Channel level not turned up 3) Input trim not turned up 4) VC1 remote control not turned up 5) Page Logic terminals shorted
2) Channel too sensitive	1) Input trim set too high 2) Mic/Line jumper in wrong position
3) Channel doesn't open	1) Input trim set too low 2) Mic/Line jumper in wrong position
4) Logic Out doesn't activate	1) Logic threshold jumper set incorrectly, see page 6
5) Logic Out too sensitive	1) Logic threshold jumper set incorrectly, see page 6



## SERVICE AND REPAIR

If your system malfunctions, you should attempt to correct or isolate the trouble before concluding that the equipment needs repair. Make sure you have followed the setup procedure and operating instructions. Check out the inter-connecting cords and then go through the TROUBLE SHOOTING section in the manual

We strongly recommend that you **do not** try to repair the equipment yourself and **do not** have the local repair shop attempt anything other than the simplest repair. If the repair is more complicated than a broken wire or loose connection, send the unit to the factory for repair and service. Don't attempt to adjust any controls inside the units. Once set at the factory, the various controls and trimmers do not drift with age or vibration and never require readjustment. **There are no adjustments inside that will make a malfunctioning unit start working.**

LECTROSONICS service department is equipped and staffed to quickly repair your equipment. In-warranty repairs are made at no charge in accordance with the terms of the warranty. Out of warranty repairs are charged at a modest flat rate plus parts and shipping. Since it takes almost as much time and effort to determine what is wrong as it does to make the repair, there is a charge for an exact quotation. We will be happy to quote approximate charges by phone for out of warranty repairs.

## RETURNING UNITS FOR REPAIR

You will save yourself time and trouble if you will follow the steps below:

- A. DO NOT return equipment to the factory for repair without first contacting us by letter or by phone. We need to know the nature of the problem, the model number and the serial number of the equipment. We also need a phone number where you can be reached 8 am to 4 pm (Mountain Standard Time).
- B. After receiving your request, we will issue you a return authorization number (R.A.). This number will help speed your repair through our receiving and repair departments. The return authorization number must be clearly shown on the outside of the shipping container.
- C. Pack the equipment carefully and ship to us, shipping costs prepaid. If necessary, we can provide you with the proper packing materials. UPS is usually the best way to ship the units. Heavy units should be "double-boxed" for safe transport.
- D. We also strongly recommend that you insure the equipment, since we cannot be responsible for loss of or damage to equipment that you ship. Of course, we insure the equipment when we ship it back to you.

Mailing address:

Lectrosonics, Inc.  
PO Box 15900  
Rio Rancho, NM 87174  
USA

Shipping address:

Lectrosonics, Inc.  
581 Laser Rd.  
Rio Rancho, NM 87124  
USA

Telephones:

(505) 892-4501  
(800) 821-1121  
FAX: (505) 892-6243

**World Wide Web:** <http://www.lectrosonics.com>

**email:** [sales@lectrosonics.com](mailto:sales@lectrosonics.com)

## SPECIFICATIONS

<b>Gain Range:</b>	20dB to 65dB in Mic mode 0dB fixed in Line mode
<b>Maximum Channel Attenuation:</b>	25dB
<b>Equivalent Input Noise, 20-20kHz:</b>	-128dBu
<b>THD, 20-20kHz:</b>	Less than 0.1% (40dB gain, 0dBu out)
<b>IMD, 60/7kHz:</b>	Less than 0.1% (40dB gain, 0dBu out)
<b>Input Impedance:</b>	2K Ohms, balanced 1K Ohms, unbalanced
<b>Input:</b>	
<b>Type:</b>	Electronically balanced RF filtered
<b>Maximum Input Level</b>	+0dBu in Mic mode (Gain at 20dB) +20dBu in Line mode
<b>Phantom Power:</b>	+15 Volts, internal jumper
<b>Power Consumption:</b>	±100mA at 15 Volts

## APPENDIX 1

The Logic Output on each channel of the CP4 is an optically isolated NPN bipolar transistor. This transistor has a breakdown voltage of 30 Volts and will provide a maximum current of about 10mA.

Shown below are two possibilities for configuring the Logic Output, depending on whether an active high or active low signal is desired.

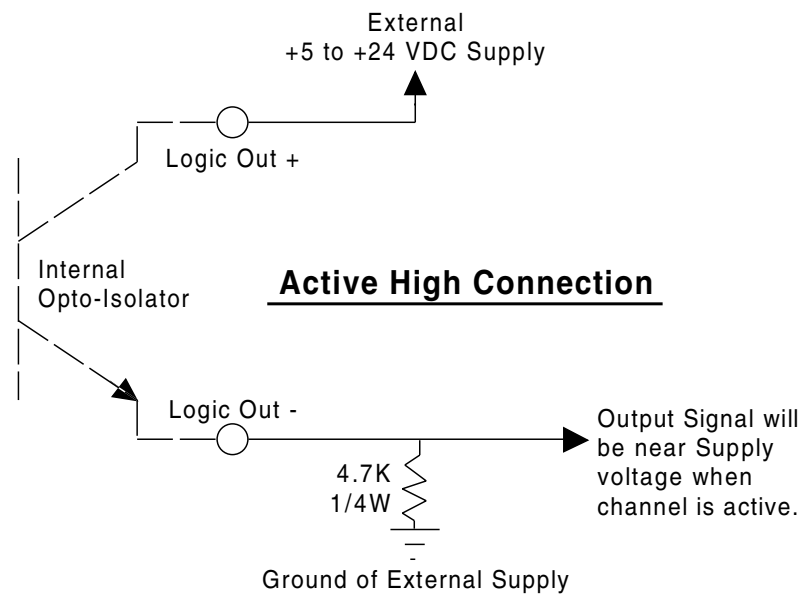
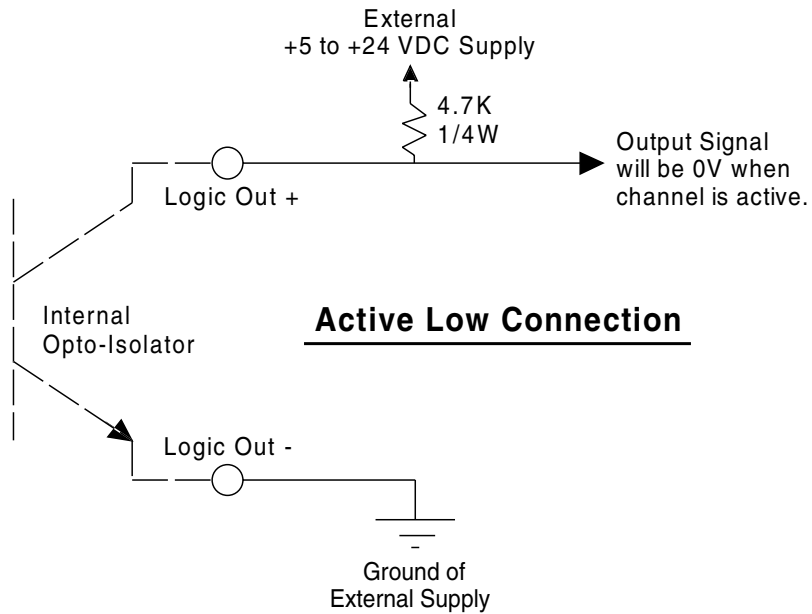

## **LIMITED ONE YEAR WARRANTY**

The equipment is warranted for one year from date of purchase against defects in materials or workmanship provided it was purchased from an authorized dealer. This warranty does not cover equipment which has been abused or damaged by careless handling or shipping. This warranty does not apply to used or demonstrator equipment.

Should any defect develop, we will, at our option, repair or replace any defective parts without charge for either parts or labor. If we cannot correct the defect in your equipment, we will replace it at no charge with a similar new item. We will pay for the cost of returning your merchandise to you.

This warranty applies only to items returned to us, shipping costs prepaid, within one year from the date of purchase.

This warranty gives you specific legal rights. You may have additional legal rights which vary from state to state.

**LECTROSONICS, INC.**

---

**581 LASER ROAD  
RIO RANCHO, NM 87124 USA**

July 7, 1999