

# DCHR

## Digital Camera Hop Receiver



### Quick Start Steps

- 1) Install receiver batteries and turn power on (pg. 5).
- 2) Set compatibility mode to match the transmitter (pg.10).
- 3) Set or sync frequency to match transmitter pg.10).
- 5) Set encryption key type and sync with transmitter (pg. 11).
- 6) Choose analog or digital (AES3) output (pg. 10).
- 7) Verify RF and audio signals are present.

**WARNING: Moisture, including talent's sweat, will damage the receiver. Wrap the DCHR in a plastic baggie, our silicone cover (order part # DCHRCVR) or other protection to avoid damage.**

Follow Us On:



Fill in for your records:

Serial Number:

Purchase Date:

CE UK  
CA

**LECTROSONICS®**  
Rio Rancho, NM, USA  
www.lectrosonics.com

# Table of Contents

Quick Start Steps..... 1

DCHR Digital 2-Channel Receiver..... 3

Smart Tuning (SmartTune™) ..... 3

Encryption ..... 3

RF Front-End with Tracking Filter ..... 3

**Panels and Features..... 4**

    Battery Status LED ..... 5

    RF Link LED ..... 5

    IR (infrared) Port..... 5

    USB Port ..... 5

    Battery Compartment..... 5

    Audio Jack and Pin Configuration ..... 5

    Keypad and LCD Interface ..... 5

**Installing Batteries ..... 6**

**System Setup Procedure ..... 6**

**DCHR LCD Menu Map ..... 8**

**Menu Item Descriptions..... 10**

**RF Setup Menu ..... 10**

**Audio Setup Menu ..... 10**

    Sync/Encryption Menu ..... 10

**Tools/Settings ..... 11**

**Supplied Accessories..... 13**

**Optional Accessories ..... 13**

**Specifications ..... 14**

**Service and Repair ..... 14**

    Returning Units for Repair..... 14

NOTE: This equipment has been tested and found to comply with the limits for a Class B digital device, pursuant to part 15 of the FCC Rules. These limits are designed to provide reasonable protection against harmful interference in a residential installation. This equipment generates, uses and can radiate radio frequency energy and, if not installed and used in accordance with the instructions, may cause harmful interference to radio communications. However, there is no guarantee that interference will not occur in a particular installation. If this equipment does cause harmful interference to radio or television reception, which can be determined by turning the equipment off and on, the user is encouraged to try to correct the interference by one or more of the following measures:

- Reorient or relocate the receiving antenna.
- Increase the separation between the equipment and receiver.
- Connect the equipment into an outlet on a circuit different from that to which the receiver is connected.
- Consult the dealer or an experienced radio/TV technician for help.

## DCHR Digital Stereo/Mono Receiver

The DCHR Digital Receiver is engineered to work alongside the DCHT transmitter to form the Digital Camera Hop system. The receiver is also compatible with the M2T unencrypted and M2T-X encrypted digital stereo transmitters, and the D2 Series mono digital transmitters, including the DBu, DHu, and DPR. Designed to be camera mountable and battery powered, the receiver is ideal for location sound and televised sports, along with many other applications. The DCHR employs advanced antenna diversity switching during digital packet headers for seamless audio. The receiver tunes across a wide UHF frequency range.

The DCHR has a single audio output jack that can be configured as 2 independent balanced line level outputs or as a single 2 channel AES3 digital output.

The headphone monitor output is fed from a high-quality stereo amplifier with power available to drive even inefficient headphones or earphones to sufficient levels for noisy environments. An intuitive interface and high resolution LCD on the unit provide users with a quick read on the status of the system.

The DCHR also employs 2-way IR sync, so settings from the receiver can be sent to a transmitter. This way, frequency planning and coordination can be done quickly and confidently with on-site RF information.

## Smart Tuning (SmartTune™)

A major problem facing wireless users is finding clear operating frequencies, especially in RF saturated environments. SmartTune™ overcomes this problem by automatically scanning all the frequencies available in the unit, and tuning to the frequency with the lowest RF interference, significantly reducing setup time.

## Encryption

The DCHR provides AES 256-bit, CTR mode encryption. When transmitting audio, there are situations where privacy is essential, such as during professional sporting events. High entropy encryption keys are first created by the DCHR. The key is then synced with an encryption capable transmitter/receiver via the IR port. The audio will be encrypted and can only be decoded and heard if both the transmitter and the DCHR have the matching key. Four key management policies are available.

## RF Front-End with Tracking Filter

A wide tuning range is helpful in finding clear frequencies for operation, however, it also allows a greater range of interfering signals to enter the receiver. The UHF frequency band, where almost all wireless microphone systems operate, is heavily populated by high power TV transmissions. The TV signals are immensely more powerful than a wireless microphone or portable transmitter signal and will enter the receiver even when they are on significantly different frequencies than the wireless system. This powerful energy appears as noise to the receiver, and has the same effect as the noise that occurs with extreme operating range of the wireless system (noise bursts and dropouts). To alleviate this interference, high-quality front-end filters are needed in the receiver to suppress RF energy below and above the operating frequency.

The DCHR receiver employs a selective frequency, tracking filter in the front-end section (the first circuit stage following the antenna). As the operating frequency is changed, the filters re-tune into six different “zones” depending on the selected carrier frequency.

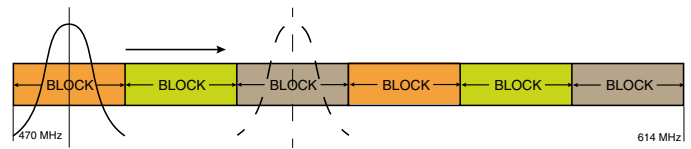

In the front-end circuitry, a tuned filter is followed by an amplifier and then another filter to provide the selectivity needed to suppress interference, yet provide a wide tuning range and retain the sensitivity needed for extended operating range.

# Panels and Features

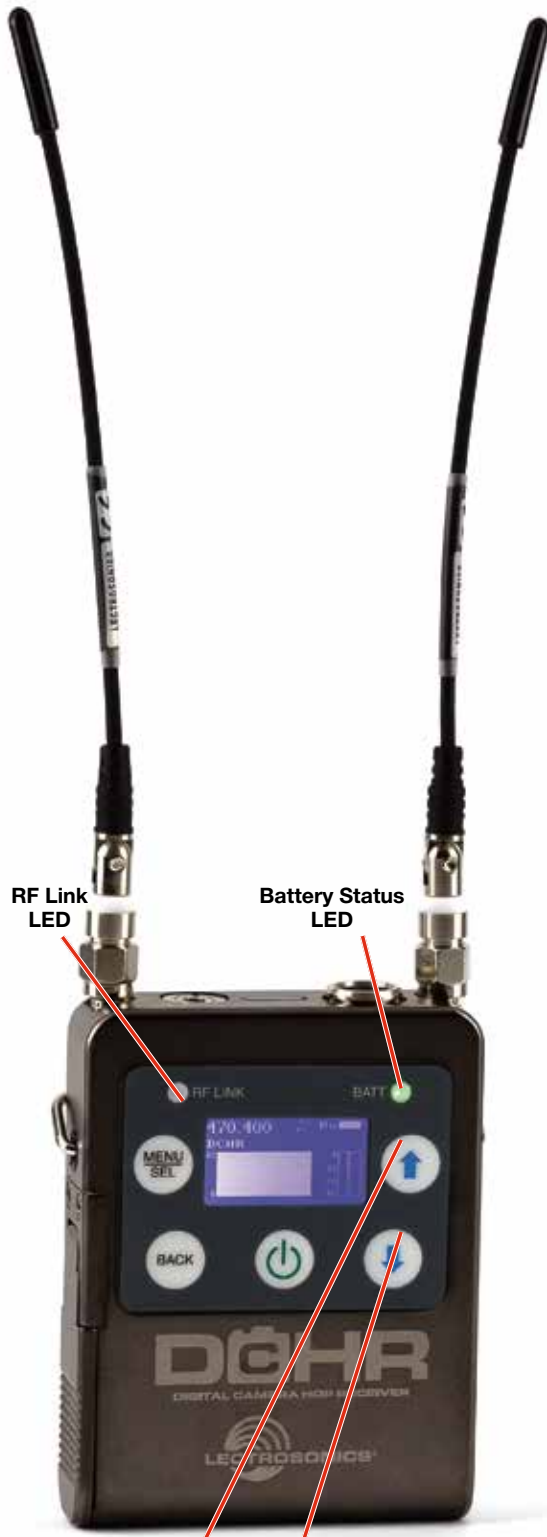

When on Main Screen, UP and DOWN buttons will adjust headphone volume.



## Battery Status LED

When the battery status LED on the keypad glows green the batteries are good. The color changes to red at a midpoint during the runtime. When the LED begins to **blink** red, only a few minutes remain.

The exact point at which the LED turns red will vary with battery brand and condition, temperature and power consumption. The LED is intended to simply catch your attention, not to be an exact indicator of remaining time. The proper battery type setting in the menu will increase accuracy.

A weak battery will sometimes cause the LED to glow green immediately after the transmitter is turned on, but it will soon discharge to the point where the LED will turn red or the unit will turn off completely.

## RF Link LED

When a valid RF signal from a transmitter is received, this LED will light up blue.

## IR (infrared) Port

Settings, including frequency, name, compatibility mode, etc. can be transferred between receiver and transmitter.

## Outputs

### Headphone Monitor

A recessed, high duty cycle 3.5 mm stereo jack is provided for standard headphones and earphones.

### Audio Jack (TA5M mini XLR):

- AES3
- Analog Line Out

The 5-pin output jack provides two discrete AES digital or line-level analog outputs. The connections are configured as follows:

	ANALOG	DIGITAL
Pin 1	CH 1 and CH 2 Shield/Gnd	AES GND
Pin 2	CH 1 +	AES CH 1
Pin 3	CH 1 -	AES CH 2
Pin 4	CH 2 +	-----
Pin 5	CH 2 -	-----

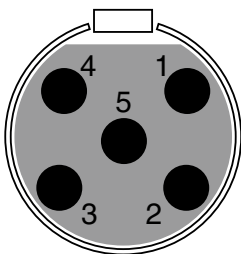

TA5FLX connector viewed from outside

## USB Port

Firmware updates via Wireless Designer software are made easy with the USB port on the side panel.

## Battery Compartment

Two AA batteries are installed as marked on the rear panel of the receiver. The battery door is hinged and remains attached to the housing.

## Keypad and LCD Interface

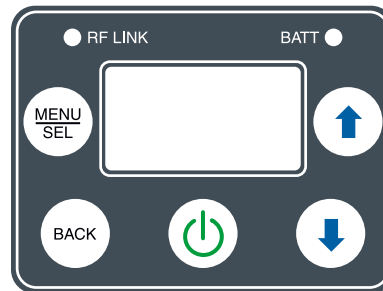

### MENU/SEL Button

Pressing this button enters the menu and selects menu items to enter the setup screens.

### BACK Button

Pressing this button returns to the previous menu or screen.

### POWER Button

Pressing this button turns the unit on or off.

### Arrow Buttons

Used to navigate the menus. When on Main Screen, UP Button will turn LEDs on and DOWN Button will turn LEDs off.

## Installing Batteries

Power is provided by two AA batteries. The batteries are connected in series by a plate in the battery door. It is suggested that you use lithium or high capacity NiMH rechargeable batteries.



Slide the battery door outward to open it

Polarity is marked on the rear panel.

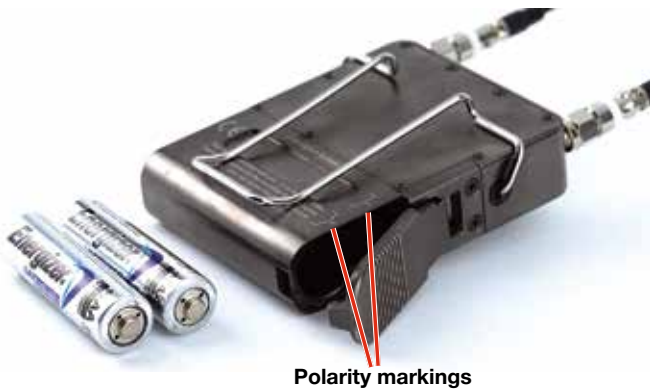

Polarity markings

## System Setup Procedure

### Step 1) Install Batteries and Turn Power On

Install the batteries according to the diagram marked on the back of the housing. The battery door makes a connection between the two batteries. It is suggested that you use lithium or high capacity NiMH rechargeable batteries.

### Step 2) Set Compatibility Mode

Set compatibility mode according to the transmitter type, and make sure the transmitter compatibility mode is the same in the case where the transmitter offers different modes.

### Step 3) Set or Sync Frequency to match Transmitter

In the transmitter, use "GET FREQ" or "GET ALL" in the menu to transfer frequency or other information via the IR ports. Hold the DCHR receiver IR port close to the front panel IR port on the transmitter and press GO on the transmitter. You can also use SMART TUNE to automatically select frequency.

### Step 4) Set Encryption Key Type and Sync with Transmitter

Choose Encryption Key Type. If necessary, create key and use "SEND KEY" in the menu to transfer an encryption key via the IR ports. Hold the DCHR receiver IR port close to the front panel IR port on the transmitter and press GO on the transmitter.

### Step 6) Choose Audio Output Function

Choose analog or digital (AES3) output as desired.

### Step 7) Verify RF and Audio Signals are Present

Send an audio signal to the transmitter and the receiver audio meters should respond. Plug in headphones or earphones. (Be sure to start with the receiver volume settings at a low level!)

## LCD Main Window

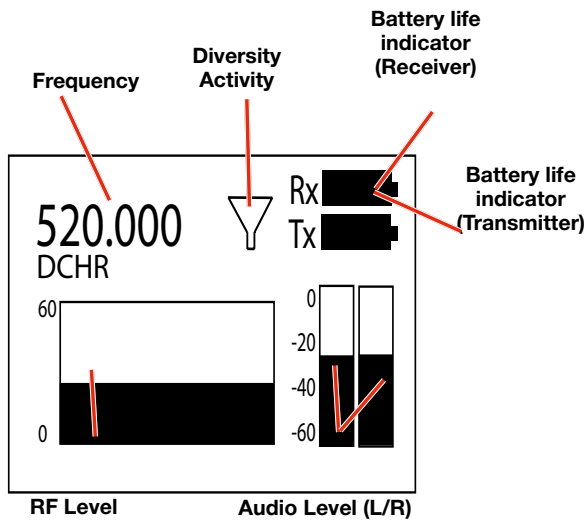

### RF level

The six second strip chart shows RF levels over time. If a transmitter is not on, the chart shows the RF noise floor on that frequency.

### Diversity activity

The two antenna icons will alternately light up depending on which one is receiving the stronger signal.

### Battery life indicator

The battery life icon is an approximate indicator of the remaining battery life. For the most accurate indication, the user should select "Battery Type" in the menu and select Alkaline or Lithium.

### Audio level

This bar graph indicates the level of the audio entering the transmitter. The "0" refers to the level reference, as chosen in the transmitter, i.e. either +4 dBu or -10 dBV.

## Navigating the Menu

From the Main Window, press MENU/SEL to enter the menu, then navigate with the UP and DOWN arrows to highlight the desired setup item. Press MENU/SEL to enter the setup screen for that item. Refer to the menu map on the following page.

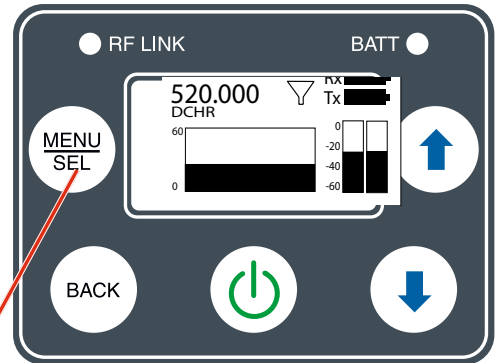

Press MENU/SEL to enter the menu

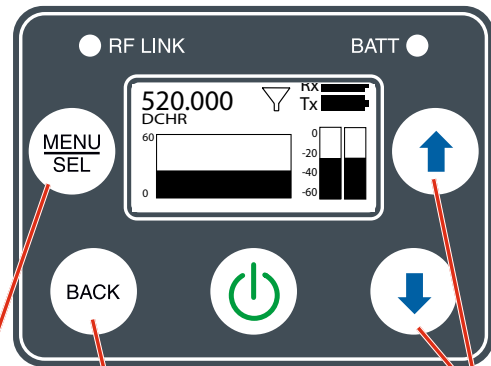

Press MENU/SEL to enter the setup of the highlighted item

Press BACK to return to the previous screen

Press the UP and DOWN arrows to navigate and highlight the desired menu item



# DCHR LCD Menu Map

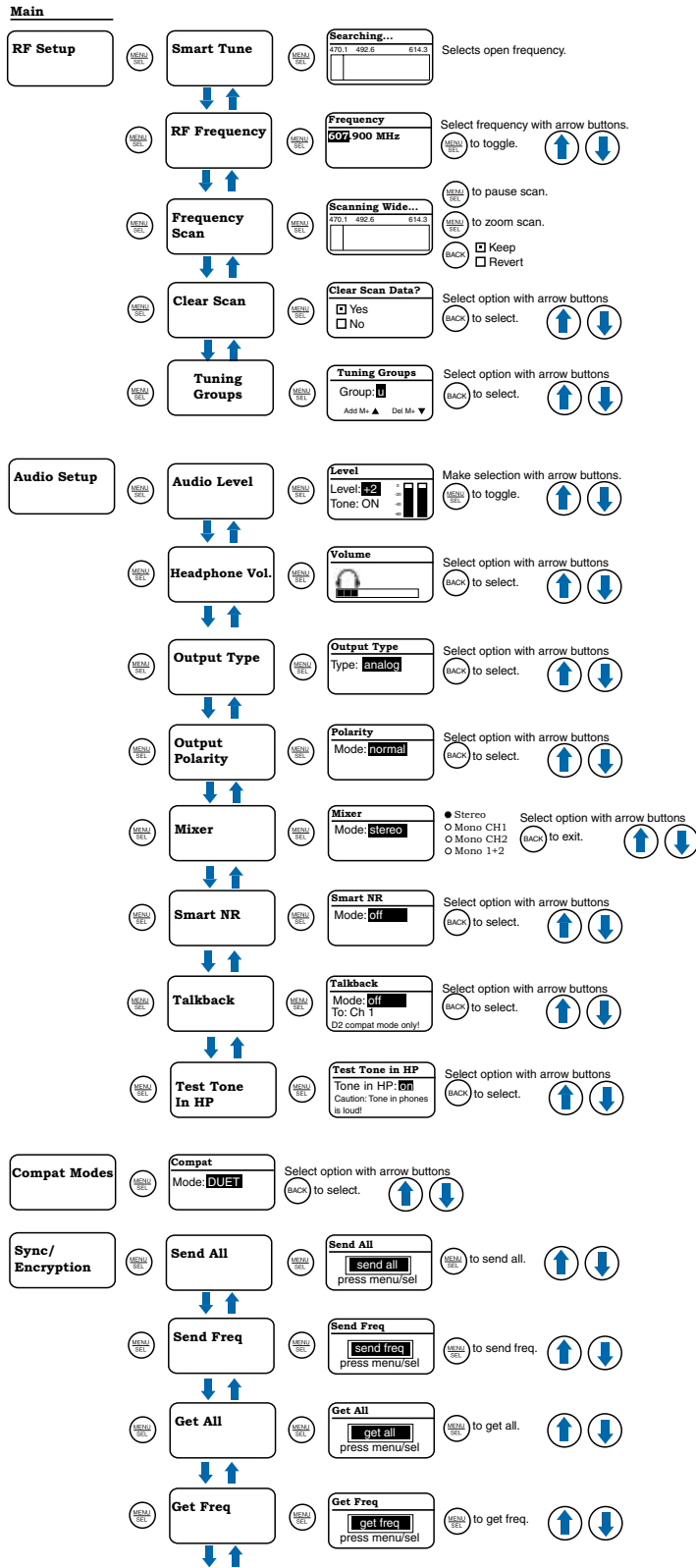



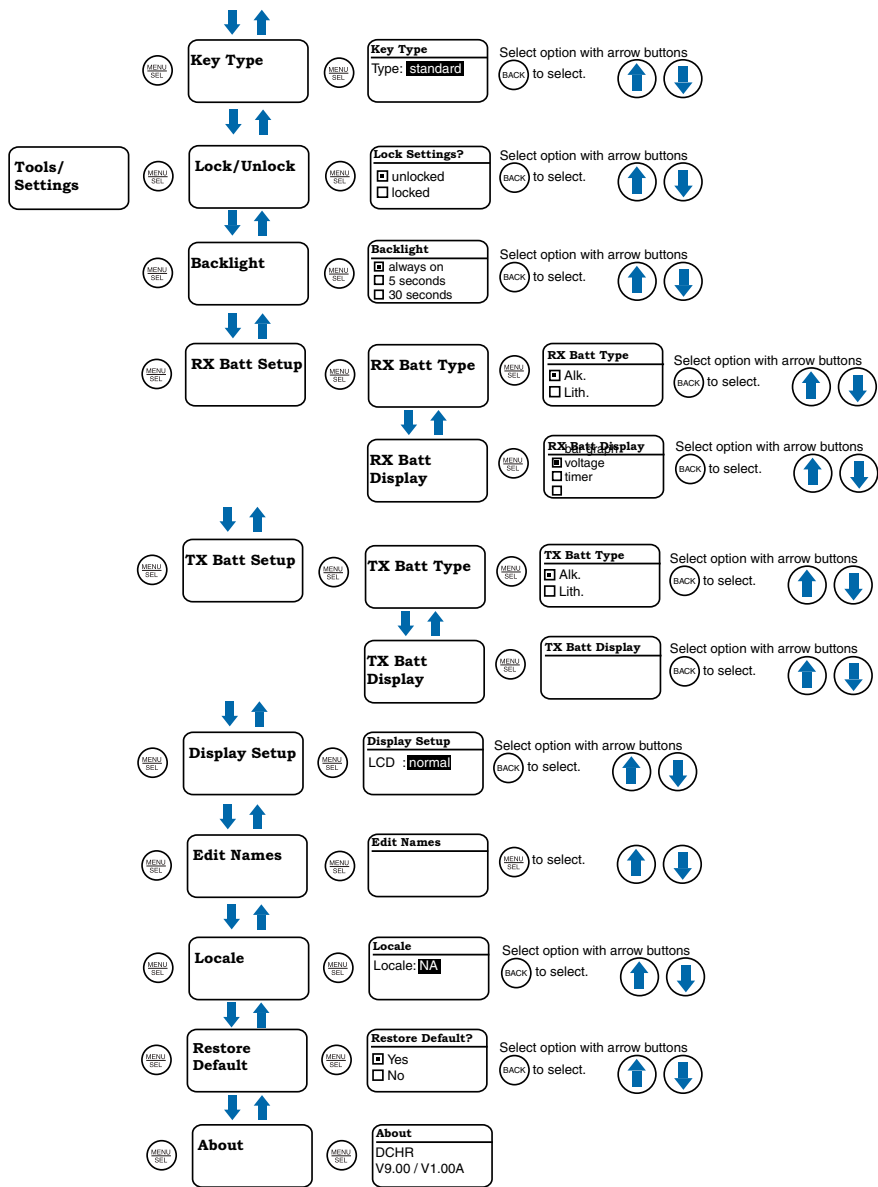

# Menu Item Descriptions

## RF Setup Menu

### SmartTune

SmartTune™ automates the discovery of a clear operating frequency. It does this by scanning all the available operating frequencies within the system's frequency range (in 100 kHz increments) and then selecting the frequency with the least amount of RF interference. When SmartTune™ is complete, it presents the IR Sync function for transferring the new setting to the transmitter. Pressing "Back" returns to the Main Window displaying the selected operating frequency.

### RF Frequency

Allows manual selection of the operating frequency in MHz and kHz, tunable in 25 kHz steps.

You may also select a Frequency Group, which will limit the available frequency choices to those contained in the selected group (see Freq. Group Edit, below). Select Frequency Group NONE for normal tuning.

### Frequency Scan

Use the scan function to identify a usable frequency. Allow the scan to continue until the entire band has been scanned.

Once a full cycle has been completed, press MENU/SELECT again to pause the scan.

Use the UP and DOWN arrows to roughly tune the receiver by moving the cursor to an open spot. Press MENU/SELECT to zoom in for fine tuning.

When a usable frequency has been selected, press the BACK button for the option to keep your newly selected frequency or to revert to where it was set before the scan.

### Clear Scan

Erases scan results from memory.

### Freq. Group Edit

User-defined Frequency Groups are edited here. Groups **u**, **v**, **w** and **x** may contain up to 32 user-selected frequencies. Use the UP and DOWN arrow buttons to select one of the four groups. Press the MENU/SELECT button to move the cursor to the frequency list for the group. Now, pressing the UP and DOWN arrow buttons moves the cursor in the list. To delete a selected frequency from the list, press MENU/SELECT + DOWN. To add a frequency to the list, press MENU/SELECT + UP. This opens the Frequency Selection screen. Use the UP and DOWN arrow buttons to select the desired frequency (in MHz and kHz). Press MENU/SELECT to advance from MHz to kHz. Press MENU/SELECT again to add the frequency. This opens a confirmation screen, where you can choose to add the frequency to the Group or cancel the operation.

In addition to the group NONE, this screen also allows selection of one of four user-defined pre-selected frequency groups (Groups u through x):

- Each press of the UP or DOWN button will step to the next stored frequency in the group.

## Audio Setup Menu

### Audio Level

Set audio output level with the level control. The **TONE** option is used to generate a 1 kHz test tone at the audio output.

### SmartNR

For audio sources containing an undesirable amount of hiss (some lav mics, for instance), SmartNR can be used to reduce this noise without affecting the quality of the audio. The default setting for the DCHR is "Off", while "Normal" provides some noise reduction without affecting high frequency response, and "Full" is a more aggressive setting with minimal impact on the high frequency response.

### Mixer

If working with a two channel transmitter, such as a DCHT or M2T, this function allows you to hear a stereo mix, a mono mix from either audio Channel 1 (left), Channel 2 (right) or a mono mixture of both Channel 1 and 2. The chosen mix applies to all outputs (analog, digital and headphone). The following modes, which are Compatibility Mode dependent, are available:

- Stereo: Channel 1 (left) to output 1 and channel 2 (right) into output 2
- Mono Channel 1: channel 1 signal into both outputs 1 and 2
- Mono Channel 2: channel 2 signal into both outputs 1 and 2
- Mono Channel 1+2: channels 1 and 2 mixed as mono into both outputs 1 and 2

**Note:** D2 and HDM modes have Mono Channel 1+2 as the only mixer option.

## Compat Modes

Multiple compatibility modes are available to match various transmitter types.

The following modes are available:

- D2: Encrypted digital wireless channel
- DUET: Standard (unencrypted) Duet channel
- DCHX: Encrypted digital camera hop channel, also compatible with M2T-X encrypted Duet channel
- HDM: High density mode

## Output Type

The DCHR has a single audio output jack with two output type options:

- **Analog:** 2 balanced line level audio outputs, one for each audio channel sent by the DCHR. Uses 4 of the 5 pins in the connector, 2 pins for each analog audio channel plus ground.
- **AES3:** The AES3 digital signal contains both audio channels in a single signal. It uses 2 of the 5 pins in the connector plus ground.

## Audio Polarity

Select normal or inverted polarity.

## Sync/Encryption Menu

**NOTE:** You must position the transmitter's IR port directly in front of the DCHR IR port, as closely as possible, to guarantee a successful sync. A message will appear on the DCHR if the sync was successful or failed.

### Send Frequency

Choose to send frequency via IR port to a transmitter.

### Get Frequency

Choose to receive (get) frequency via IR port from a transmitter.

### Send All

Choose to send settings via IR port to a transmitter.

### Get All

Choose to receive (get) settings via IR port from a transmitter.

## Key Type

## Encryption Keys

The DCHR generates high entropy encryption keys to sync with encryption-capable transmitters and receivers. The user must select a key type and create a key in the DCHR, and then sync the key with a transmitter or another receiver (only in shared key mode).

### Encryption Key Management

The DCHR has four options for encryption keys:

- **Volatile:** This one-time only key is the highest level of encryption security. The Volatile Key exists only as long as the power in both the DCHR and the encryption capable transmitter remains on during a single session. If an encryption capable transmitter is powered off, but the DCHR has remained turned on, the Volatile Key must be sent to the transmitter again. If the power is turned off on the DCHR, the entire session concludes and a

new Volatile Key must be generated by the DCHR and sent to the transmitter via the IR port.

- **Standard:** Standard Keys are unique to the DCHR. The DCHR generates the Standard Key. The DCHR is the sole source of the Standard Key, and because of this, the DCHR may not receive (get) any Standard Keys.

- **Shared:** There are an unlimited number of shared keys available. Once generated by the DCHR and transferred to an encryption capable transmitter/receiver, the encryption key is available to be shared (synced) with other encryption capable transmitters/receivers via the IR port. When the DCHR is set to this key type, a menu item named SEND KEY is available to transfer the key to another device.

- **Universal:** This is the most convenient encryption option available. All encryption-capable Lectrosonics transmitters and receivers contain the Universal Key. The key does not have to be generated by the DCHR. Simply set a Lectrosonics encryption capable transmitter and the DCHR to Universal, and the encryption is in place. This allows for convenient encryption amongst multiple transmitters and receivers, but not as secure as creating a unique key.

**NOTE:** When the DCHR is set to Universal Encryption Key, Wipe Key and Share Key will not appear in the menu.

### Make Key

The DCHR generates high entropy encryption keys to sync with encryption-capable transmitters and receivers. The user must select a key type and create a key in the DCHR, and then sync the key with a transmitter or receiver. Not available in Universal key mode.

### Wipe Key

This menu item is only available if Key Type is set to Standard, Shared or Volatile. Press MENU/SEL to wipe the current key.

### Send Key

Send encryption keys via IR port. Not available in Universal key mode.

## Tools/Settings

### Lock/Unlock

The front panel controls can be locked to prevent unwanted changes.

### TX Batt Setup

**TX Batt Type:** Selects the type of battery being used (Alkaline or Lithium) so the remaining battery meter on the home screen is as accurate as possible. Use the Alkaline setting for NiMH.

**TX Batt Display:** Choose how battery life should be displayed, bar graph, voltage or timer.

**TX Batt Alert:** Set battery timer alert. Choose to enable/disable alert, set time in hour and minutes and reset timer.

## **RX Batt Setup**

**RX Batt Type:** Selects the type of battery being used (Alkaline or Lithium) so the remaining battery meter on the home screen is as accurate as possible. Use the Alkaline setting for NiMH.

**RX Batt Display:** Choose how battery life should be displayed, bar graph, voltage or timer.

**RX Batt Timer:** Set battery timer alert. Choose to enable/disable alert, set time in hour and minutes and reset timer.

## **Display Setup**

Choose normal or invert. When invert is chosen, the opposite colors are used for highlighting options in the menus.

## **Backlight**

Selects the length of time the backlight on the LCD remain turned on: Always on, 30 seconds, and 5 seconds.

## **Locale**

When EU is selected, SmartTune will include frequencies 607-614 MHz in the tuning range. These frequencies are not allowed in North America, so they are not available when NA locale is selected.

## **About**

Displays general information about the DCHR, including main firmware running in the receiver.

## Audio Output Cables and Connectors

### MCDTA5TA3F



*TA5F mini female locking XLR to single TA3F mini female locking XLR for two channels of AES digital audio from DCHR.*

### MCDTA5XLRM



*TA5 mini female locking XLR to full size male XLR for two channels of AES digital audio from DCHR.*

### MCTA5PT2



*TA5F mini female locking XLR to dual pig tails for two channels of analog audio from DCHR; allows custom connectors to be installed.*

### MCTA5TA3F2



*TA5F mini locking female XLR to dual TA3F mini locking XLRs, for two channels of analog audio from DCHR.*

## Supplied Accessories

### AMJ19

Swiveling Whip Antenna with Standard SMA Connector, Block 19.



### AMJ22

Antenna with swiveling SMA connector, Block 22.



### 40073 Lithium Batteries

DCHR is shipped with two (2) batteries. Brand may vary.



# Optional Accessories

## 26895

Replacement wire belt clip.



## 21926

USB cable for firmware updates



## LTBATELIM

Battery Eliminator for LT, DBu and DCHT transmitters, and M2R; camera hop and similar applications. Optional power cables include: P/N 21746 right angle, locking cable; 12 in. length P/N 21747 right angle, locking cable; 6 ft. length; DCR12/A5U universal power supply for AC power.



## LRSHOE

This kit includes the accessories needed to mount the DCHR on a standard cold shoe, using the wire belt clip that comes with the receiver.



## DCHRCVR

This tough silicone cover protects the DCHR from moisture and dust. The pliable material and the two-part design make it easy to install and remove. Cutouts for the antennas and jacks and the raised dome for the LED provide a snug fit.



## AMJ(xx) Rev. A

Whip antenna; swiveling. Specify frequency block (see chart at right).



## AMM(xx)

Whip antenna; straight. Specify frequency block (see chart below).



### About Whip Antenna Frequencies:

Frequencies for whip antennas are specified by the block number. For example, AMM-25 is the straight whip model cut to the block 25 frequency.

L-Series transmitters and receivers tune across a range covering three blocks. The correct antenna for each of these tuning ranges is the block in the middle of the tuning range.

Band	Blocks covered	Ant. Freq.
A1	470, 19, 20	Block 19
B1	21, 22, 23	Block 22
C1	24, 25, 26	Block 25

# Specifications

Operating Frequencies:	470.100 - 614.375 MHz
Operating temperature range:	-20 to 50°C; -5 to 122°F
Modulation Type:	8PSK with Forward Error Correction
Audio Performance:	
Frequency Response:	D2 mode: 25 Hz - 20 kHz, +0/-3dB Stereo modes: 20 Hz - 12 kHz, +0/-3dB
THD+N:	0.05% (1kHz @ -10 dBFS)
Dynamic Range:	>95 dB weighted
Adjacent Channel Isolation	>85dB
Diversity Type:	Switched antenna, during packet headers
Audio Output:	
Analog:	2 balanced outputs
AES3:	2 channels, 48 kHz sample rate
Headphone Monitor:	3.5 mm TRS jack
Level (line level analog):	-50 to +5dBu
Latency:	D2 mode: 1.4 ms Stereo modes: 1.6 ms
Power requirements:	2 x AA batteries (3.0V)
Battery life:	8 hours; (2) Lithium AA
Power consumption:	1 W
Dimensions:	Height: 3.34 in. / 85 mm. (measured to top of SMA connector)
	Width: 2.44 in. / 62 mm. (without wire belt clip)
	Depth: .75 in. / 19 mm. (without wire belt clip)
Weight:	9.14 ounces / 259 grams (with batteries)



## Service and Repair

If your system malfunctions, you should attempt to correct or isolate the trouble before concluding that the equipment needs repair. Make sure you have followed the setup procedure and operating instructions. Check the interconnecting cables.

We strongly recommend that you **do not** try to repair the equipment yourself and **do not** have the local repair shop attempt anything other than the simplest repair. If the repair is more complicated than a broken wire or loose connection, send the unit to the factory for repair and service. Don't attempt to adjust any controls inside the units. Once set at the factory, the various controls and trimmers do not drift with age or vibration and never require readjustment. **There are no adjustments inside that will make a malfunctioning unit start working.**

LECTROSONICS' Service Department is equipped and staffed to quickly repair your equipment. In warranty repairs are made at no charge in accordance with the terms of the warranty. Out-of-warranty repairs are charged at a modest flat rate plus parts and shipping. Since it takes almost as much time and effort to determine what is wrong as it does to make the repair, there is a charge for an exact quotation. We will be happy to quote approximate charges by phone for out-of-warranty repairs.

### Returning Units for Repair

For timely service, please follow the steps below:

- A.** DO NOT return equipment to the factory for repair without first contacting us by e-mail or by phone. We need to know the nature of the problem, the model number and the serial number of the equipment. We also need a phone number where you can be reached 8 A.M. to 4 P.M. (U.S. Mountain Standard Time).
- B.** After receiving your request, we will issue you a return authorization number (R.A.). This number will help speed your repair through our receiving and repair departments. The return authorization number must be clearly shown on the **outside** of the shipping container.
- C.** Pack the equipment carefully and ship to us, shipping costs prepaid. If necessary, we can provide you with the proper packing materials. UPS or FEDEX is usually the best way to ship the units. Heavy units should be "double-boxed" for safe transport.
- D.** We also strongly recommend that you insure the equipment, since we cannot be responsible for loss of or damage to equipment that you ship. Of course, we insure the equipment when we ship it back to you.

#### Lectrosonics USA:

**Mailing address:**  
Lectrosonics, Inc.  
PO Box 15900  
Rio Rancho, NM 87174  
USA

**Web:**  
www.lectrosonics.com

**Shipping address:**  
Lectrosonics, Inc.  
561 Laser Rd., Suite 102  
Rio Rancho, NM 87124  
USA

**E-mail:**  
service.repair@lectrosonics.com  
sales@lectrosonics.com

**Telephone:**  
+1 (505) 892-4501  
(800) 821-1121 Toll-free US and Canada  
Fax +1 (505) 892-6243

#### Lectrosonics Canada:

**Mailing Address:**  
720 Spadina Avenue,  
Suite 600  
Toronto, Ontario M5S 2T9

**Telephone:**  
+1 (416) 596-2202  
(877) 753-2876 Toll-free Canada  
(877) 7LECTRO  
Fax (416) 596-6648

**E-mail:**  
Sales: colinb@lectrosonics.com  
Service: joe@lectrosonics.com

### Self-Help Options for Non-Urgent Concerns

Our Facebook groups and weblists are a wealth of knowledge for user questions and information. Refer to:

**Lectrosonics General Facebook Group:** <https://www.facebook.com/groups/69511015699>

**D Squared, Venue 2 and Wireless Designer Group:** <https://www.facebook.com/groups/104052953321109>

**The Wire Lists:** <https://lectrosonics.com/the-wire-lists.html>



## LIMITED ONE YEAR WARRANTY

The equipment is warranted for one year from date of purchase against defects in materials or workmanship provided it was purchased from an authorized dealer. This warranty does not cover equipment which has been abused or damaged by careless handling or shipping. This warranty does not apply to used or demonstrator equipment.

Should any defect develop, Lectrosonics, Inc. will, at our option, repair or replace any defective parts without charge for either parts or labor. If Lectrosonics, Inc. cannot correct the defect in your equipment, it will be replaced at no charge with a similar new item. Lectrosonics, Inc. will pay for the cost of returning your equipment to you.

This warranty applies only to items returned to Lectrosonics, Inc. or an authorized dealer, shipping costs prepaid, within one year from the date of purchase.

This Limited Warranty is governed by the laws of the State of New Mexico. It states the entire liability of Lectrosonics Inc. and the entire remedy of the purchaser for any breach of warranty as outlined above. **NEITHER LECTROSONICS, INC. NOR ANYONE INVOLVED IN THE PRODUCTION OR DELIVERY OF THE EQUIPMENT SHALL BE LIABLE FOR ANY INDIRECT, SPECIAL, PUNITIVE, CONSEQUENTIAL, OR INCIDENTAL DAMAGES ARISING OUT OF THE USE OR INABILITY TO USE THIS EQUIPMENT EVEN IF LECTROSONICS, INC. HAS BEEN ADVISED OF THE POSSIBILITY OF SUCH DAMAGES. IN NO EVENT SHALL THE LIABILITY OF LECTROSONICS, INC. EXCEED THE PURCHASE PRICE OF ANY DEFECTIVE EQUIPMENT.**

This warranty gives you specific legal rights. You may have additional legal rights which vary from state to state.

