

M2C

Active Antenna Combiner



Follow Us On:



Fill in for your records:

Serial Number:

Purchase Date:



ISED Notices:**Per RSS-210**

This device operates on a no-protection no-interference basis. Should the user seek to obtain protection from other radio services operating in the same TV bands, a radio licence is required. Please consult Industry Canada's document CPC-2-1-28, Optional Licensing for Low-Power Radio Apparatus in the TV Bands, for details.

Ce dispositif fonctionne selon un régime de non-brouillage et de non-protection. Si l'utilisateur devait chercher à obtenir une certaine protection contre d'autres services radio fonctionnant dans les mêmes bandes de télévision, une licence radio serait requise. Pour en savoir plus, veuillez consulter le document CPC-2-1-28 d'Industrie Canada intitulé, Délivrance de licences sur une base volontaire pour les appareils radio de faible puissance exempts de licence et exploités dans les bandes de télévision.

Per RSS-Gen

This device complies with Industry Canada's license-exempt RSSs. Operation is subject to the following two conditions:

- 1) This device may not cause interference*
- 2) This device must accept any interference, including interference that may cause undesired operation of the device.*

Le présent appareil est conforme aux CNR d'Industrie Canada applicables aux appareils radio ex-empts de licence. L'exploitation est autorisée aux deux conditions suivantes :

- 1) l'appareil ne doit pas produire de brouillage;*
- 2) l'appareil doit accepter tout brouillage radioélectrique subi, même si le brouillage est susceptible d'en compromettre le fonctionnement.*

Important Safety Instructions



This symbol, wherever it appears, alerts you to the presence of uninsulated dangerous voltage inside the enclosure -- voltage that may be sufficient to constitute a risk of shock.



This symbol, wherever it appears, alerts you to important operating and maintenance instructions in the accompanying literature. Please read the manual.

1. Read these instructions.
2. Keep these instructions.
3. Heed all warnings.
4. Follow all instructions.
5. Do not use this apparatus near water.
6. Clean only with dry cloth.
7. Do not block any ventilation openings. Install in accordance with the manufacturer's instructions.
8. Do not install near any heat sources such as radiators, heat registers, stoves, or other apparatus (including amplifiers) that produce heat.
9. Do not defeat the safety purpose of the polarized or grounding-type plug. A polarized plug has two blades with one wider than the other. A grounding type plug has two blades and a third grounding prong. The wide blade or the third prong are provided for your safety. If the provided plug does not fit into your outlet, consult an electrician for replacement of the obsolete outlet.
10. Protect the power cord from being walked on or pinched particularly at plugs, convenience receptacles, and the point where they exit from the apparatus.
11. Only use attachments/accessories specified by the manufacturer.
12. Use only with the cart, stand, tripod, bracket, or table specified by the manufacturer, or sold with the apparatus. When a cart is used, use caution when moving the cart/apparatus combination to avoid injury from tip-over.
13. Unplug this apparatus during lightning storms or when unused for long periods of time.



WARNING:

TO REDUCE THE RISK OF FIRE OR ELECTRIC SHOCK, DO NOT EXPOSE THIS APPARATUS TO RAIN OR MOISTURE.

CAUTION:

TO REDUCE THE RISK OF ELECTRIC SHOCK, DO NOT REMOVE COVER. NO USER SERVICEABLE PARTS INSIDE. REFER SERVICING TO QUALIFIED SERVICE PERSONNEL.

14. Refer all servicing to qualified service personnel. Servicing is required when the apparatus has been damaged in any way, such as power-supply cord or plug is damaged, liquid has been spilled or objects have fallen into the apparatus, the apparatus has been exposed to rain or moisture, does not operate normally, or has been dropped.
15. **Damage Requiring Service**
Unplug the apparatus from the wall outlet and refer servicing to qualified service personnel under the following conditions:
 - A. When the power-supply cord or plug is damaged,
 - B. If liquid has been spilled, or objects have fallen into the apparatus,
 - C. If the apparatus has been exposed to rain or water,
 - D. If the apparatus does not operate normally by following the operating instructions. Adjust only those controls that are covered by the operating instructions as an improper adjustment of other controls may result in damage and will often require extensive work by a qualified technician to restore the apparatus to its normal operation,
 - E. If the apparatus has been dropped or damaged in any way, and
 - F. When the apparatus exhibits a distinct change in performance, this indicates a need for service.
16. **Object and Liquid Entry**
Never push objects of any kind into the apparatus through openings as they may touch dangerous voltage points or short-out parts that could result in a fire or electric shock.
17. If you install the apparatus in a built-in installation, such as a bookcase or rack, ensure that there is adequate ventilation.

Remarques importantes pour votre sécurité



L'éclair fléché dans un triangle équilatéral veut attirer l'attention de l'utilisateur sur le risque d'électrocution que présentent certains circuits internes non isolés.



Le point d'exclamation dans un triangle équilatéral veut attirer l'attention de l'utilisateur sur l'importance de certaines instructions concernant l'entretien et l'utilisation du produit.

1. Lisez attentivement ces instructions.
2. Veuillez les conserver pour vous y référer.
3. Tenez compte de tous les avertissements.
4. Suivez chaque instruction.
5. N'utilisez pas cet appareil près de l'eau.
6. Essuyez le boîtier avec un chiffon sec uniquement.
7. Ne bloquez pas les orifices d'aération et installez cet appareil selon les instructions du fabricant.
8. Ne l'installez pas près des sources de chaleur tels les calorifères, plinthes et radiateurs électriques, bouches de chauffage, poêles, ou tout autre appareil générant de la chaleur, comme les amplificateurs.
9. N'essayez pas de circonvenir les dispositifs de sécurité que représentent une fiche polarisée ou une fiche avec mise à la terre. Pour référence, une fiche polarisée possède deux lames dont l'une est plus large que l'autre, tandis qu'une fiche avec mise à la terre possède deux lames identiques et une broche de mise à la terre. La lame la plus large ou la broche assurent votre sécurité. Si la fiche de l'appareil ne peut être insérée dans la prise murale, demandez à un électricien de remplacer la prise désuète.
10. Protégez le cordon d'alimentation pour qu'on ne puisse pas marcher dessus ou le plier de façon excessive (particulièrement près des fiches, des cache-câbles et à la sortie de l'appareil).
11. N'utilisez que des fixations et accessoires préconisés par le fabricant.
12. N'utilisez l'appareil qu'avec un chariot, support ou trépied, une fixation ou une table approuvé(e) par le fabricant ou vendu(e) avec l'appareil. Tout chariot contenant l'appareil doit toujours être déplacé avec précaution afin d'éviter qu'il ne se renverse et blesse quelqu'un.



ATTENTION :

AFIN DE RÉDUIRE LES RISQUES DE DÉCHARGE ÉLECTRIQUE ET D'INCENDIE, N'EXPOSEZ PAS CET APPAREIL À L'HUMIDITÉ OU À LA PLUIE.

DANGER:

POUR ÉVITER TOUT DANGER DE DÉCHARGE ÉLECTRIQUE, N'OUVREZ PAS LE BOÎTIER OU LE PANNEAU ARRIÈRE DE L'APPAREIL. NE CONFIEZ L'ENTRETIEN ET LES RÉPARATIONS QU'À UN TECHNICIEN QUALIFIÉ.

13. Débranchez l'appareil durant un orage ou s'il reste inutilisé longtemps.
14. Veuillez faire appel à un technicien qualifié pour l'entretien et les réparations. Une réparation est indispensable si l'appareil a été endommagé d'une façon ou d'une autre : cordon d'alimentation ou fiche endommagée, petits objets ou liquide renversé dans l'appareil, exposition à la pluie ou à une humidité excessive, chute de l'appareil, ou si son fonctionnement est anormal.
15. **Dommages nécessitant une réparation**
Débranchez l'appareil et confiez-le à un technicien qualifié lorsque:
 - A. Le cordon d'alimentation ou sa fiche sont endommagés.
 - B. Du liquide a été déversé ou des objets sont tombés à l'intérieur de l'appareil.
 - C. L'appareil a été exposé à la pluie.
 - D. L'appareil ne semble pas fonctionner normalement lorsque vous l'utilisez suivant les instructions. Ne modifiez que les réglages autorisés dans le manuel, car le mauvais réglage d'autres commandes pourrait endommager l'appareil, nécessitant une longue et coûteuse remise en état par un technicien qualifié.
 - E. L'appareil a été échappé ou subi d'autres dommages.
 - F. Lorsque ses performances semblent soudainement détériorées.
16. **Présence de corps étrangers ou de liquide.**
N'insérez aucun objet à l'intérieur de l'appareil, car ils pourraient faire contact avec un point de tension dangereux ou provoquer un court-circuit avec les risques d'électrocution ou d'incendie qui en découlent.
17. Si vous devez encastrer cet appareil dans un meuble, une bibliothèque ou toute autre installation permanente, assurez-en la ventilation adéquate.

Introduction

The M2C active antenna combiner is designed as an ideal matching component to Lectrosonics digital transmitters. Up to eight transmitters can feed a single antenna to minimize cabling in multi-channel systems. The inputs are isolated to minimize crosstalk and IM (intermodulation) between RF channels.

The overall architecture of the design provides excellent performance with low power consumption and heat buildup. Front panel indicators display active status of RF inputs. A USB port on the front panel is provided for firmware updates.

Up to 100mW can be delivered to each input port without generating IM (intermodulation) signals due to the use of high overload components. Input signals above 50mW are attenuated automatically to maintain the 50mW maximum output. Front panel LEDs indicate the operating status and various fault modes.

Three cooling fans are employed to maintain the operating temperature. One fan is dedicated to the output amplifier and runs all the time. Two variable speed fans are mounted on the rear panel to exhaust heat from the interior of the chassis.

M2C Combiner Block Diagram

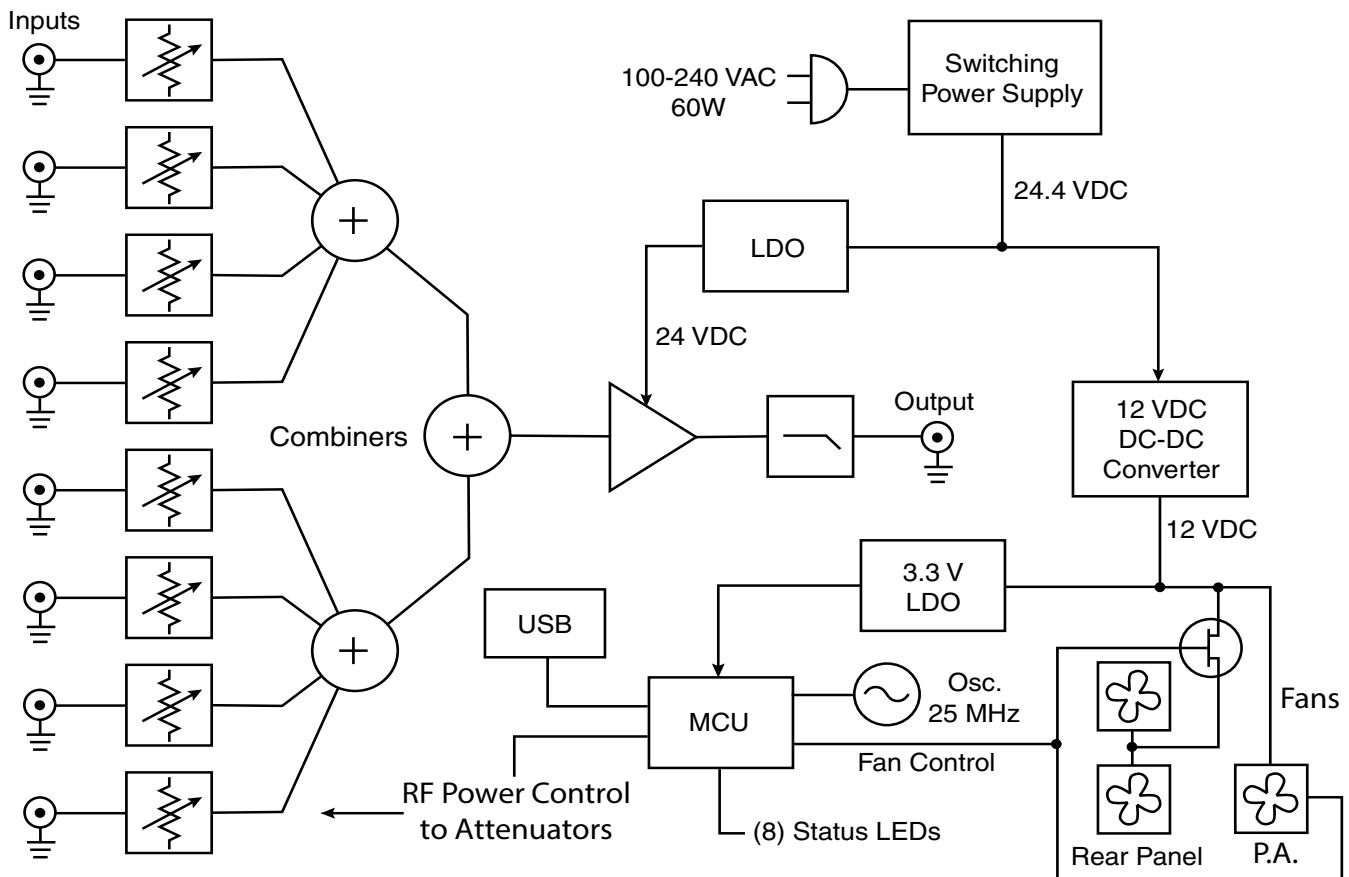

Front Panel

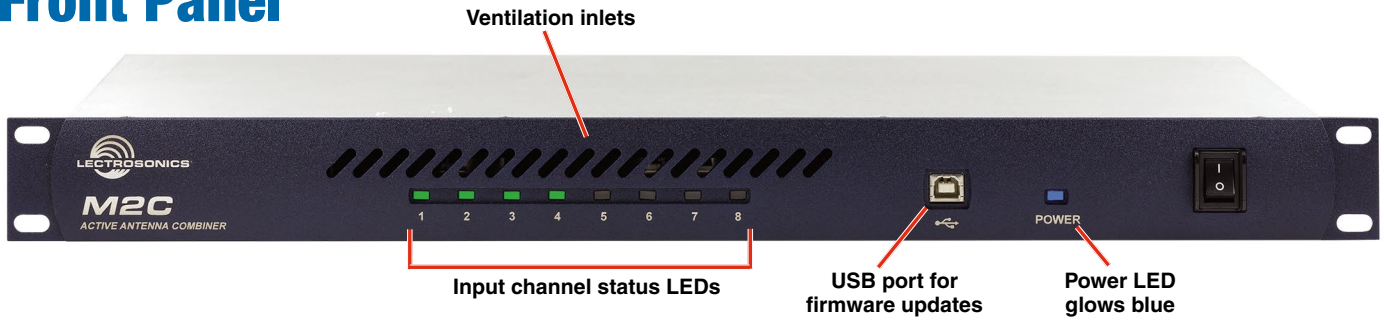

Rear Panel

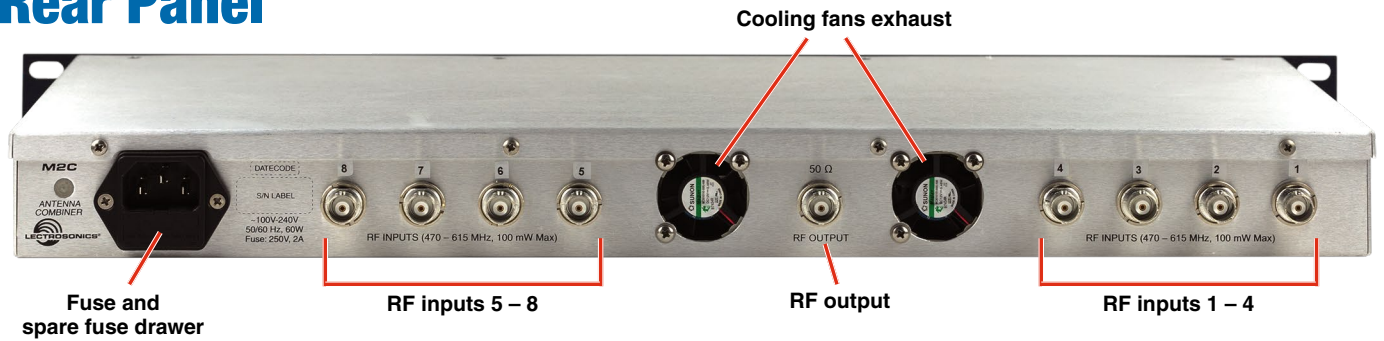

System Configuration

Up to eight transmitters can be connected to the M2C on frequencies from 470.100 to 614.375 MHz. The combiner mixes the incoming RF signals and delivers the mix to the final amplifier. The maximum RF output power is 50mW.

The combiner applies maximum attenuation to each input channel until an RF signal is present at +5dBm or greater. Once the input channel is “active,” the signal power is monitored and attenuation is applied as needed. If the signal is greater than +17dBm (50mW), the attenuator will reduce it to +17dBm.

When the transmitters are placed close to the combiner, the type of coaxial cable is not critical, but low loss 50 ohm cable is recommended. At longer cable runs, low loss cable is more important.

If the transmitters are greater than 50mW, cable loss is generally not a concern, unless the loss is considerable and the resulting signal entering the combiner is less than 50mW. The combiner does not apply gain to increase the incoming RF signal level.

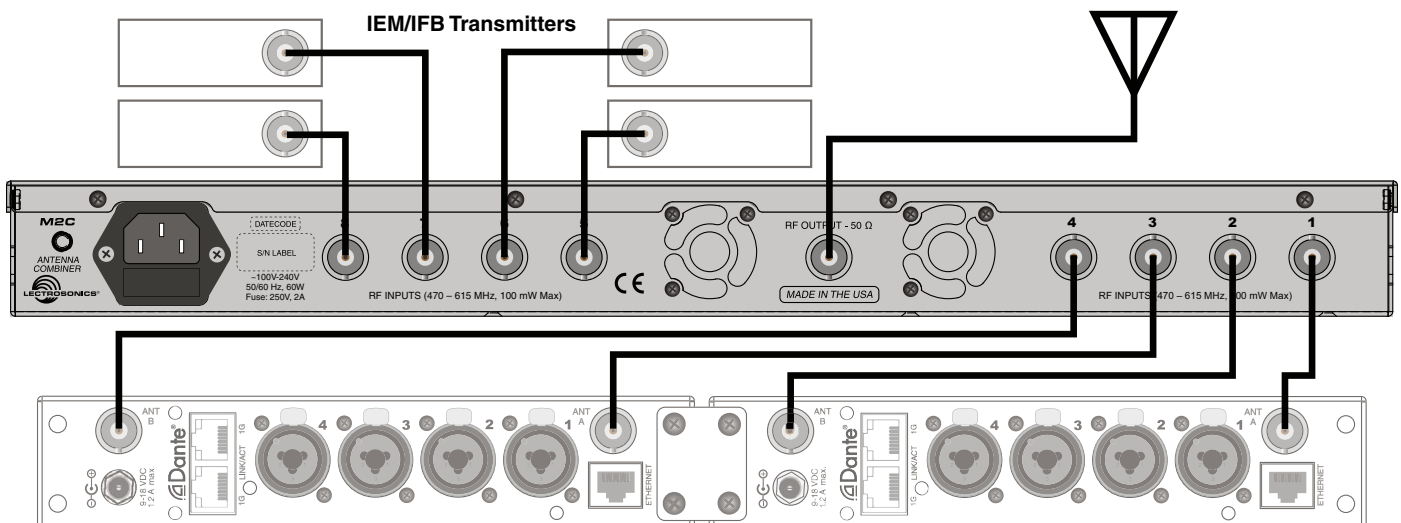

Lectrosionics M2T IEM/IFB Transmitter

Setup and Operation

Installation

The M2C antenna combiner can be installed in a 19 inch rack with other devices directly above and below it. Adequate ventilation in normal conditions is provided by the front and side panel vent openings and the rear panel fans. If another device that generates excessive heat is mounted below this combiner, it is possible that the internal temperature could reach a high enough point to cause the combiner to shut down. If this happens, the front panel LEDs will indicate the condition as described under **LED Indicators**.

Setup

- 1) Turn the power switch off and then connect the AC power to the mains outlet and the combiner.
- 2) Connect the output antenna to the rear panel jack.
- 3) Connect the coaxial cables from the transmitters to the input jacks on the rear of the combiner.
- 4) Turn the power on and observe the front panel LEDs.
- 5) The LED for each input channel will indicate the status as described under **LED Indicators**.

LED Indicators

Front panel LEDs glow and blink different colors to indicate various operating modes and fault conditions.

Operating Modes:

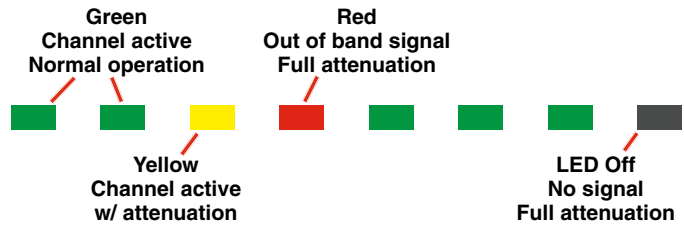

If a channel LED is off, it means there is no usable signal present and the attenuator will be at the maximum level (30 dB down) to suppress potential noise. When no channels are active, the RF amplifier is turned off.

Each channel will become active and the associated LED will glow green when an RF signal at +5dBm (3.16 mW) or greater is present. If the signal is greater than +17dBm (50 mW) the channel will be active, but the attenuator will reduce the signal to +17dBm and the channel LED will glow yellow.

If the incoming signal is out of the frequency band of the combiner, the channel LED will glow red and full attenuation will be applied.

Fan Operation Fault:

If one of the fans stops turning, all front panel LEDs will blink yellow.

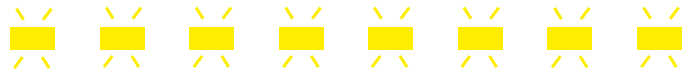

High Temperature Warning:

If the internal temperature rises to 80°C (176°F) the front panel LEDs will blink red, alternating with the operating mode indications.

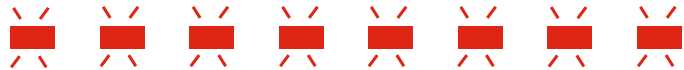

High Temperature Shutdown:

If the internal temperature reaches 85°C (185°F) the RF amplifiers will be turned off and the front panel LEDs will blink red rapidly. When the combiner is in this state, the power must be turned off and the unit allowed to cool before powering up again.



Replacement Power Cords

- P/N 21499: NEMA 5-15 plug to IEC 60320 C13 connector; 6 ft. length; North America
- P/N 21642: CEE 7/7 plug to IEC 60320 C13 connector; 2.4 meter length; Continental Europe
- P/N 21643: BS 1363 plug to C13 connector; 2.4 meter length; United Kingdom

Optional Accessories

- ARG2 coaxial cable; BNC male to male; RG-8X; Belden 9258; 0.25 dB loss; 2 ft. length
- ARG15 coaxial cable; BNC male to male; RG-8X; Belden 9258; 1.4 dB loss; 15 ft. length
- ARG25 coaxial cable; BNC male to male; RG-8/U; Belden 9913F7; 1.9 dB loss; 25 ft. length
- P/N 21499 power cord; NEMA 5-15 plug to IEC 60320 C13 connector; 6 ft. length; North America

Specifications

RF frequency range:	470.100 to 614.375 MHz
Input impedance:	50 ohm
Output impedance:	50 ohm
Input connectors:	(8) BNC; 50 ohm
Output connector:	BNC; 50 ohm
RF gain:	0dB
Indicators:	LEDs; glow green when signal present; blink red with fault
RF input threshold for LED indication:	5dBm
Operating temperature range:	-20 to 50° C
Power requirements:	100-240 VAC; 50/60 Hz
Power consumption:	60W maximum
Power inlet fuse:	250 VAC, 2A
Dimensions:	19.00 x 1.75 x 9.50 in. 483 x 45 x 241 mm.

Service and Repair

If your system malfunctions, you should attempt to correct or isolate the trouble before concluding that the equipment needs repair. Make sure you have followed the setup procedure and operating instructions. Check the inter-connecting cables and then go through the **Troubleshooting** section in this manual.

We strongly recommend that you **do not** try to repair the equipment yourself and **do not** have the local repair shop attempt anything other than the simplest repair. If the repair is more complicated than a broken wire or loose connection, send the unit to the factory for repair and service. Don't attempt to adjust any controls inside the units. Once set at the factory, the various controls and trimmers do not drift with age or vibration and never require readjustment. **There are no adjustments inside that will make a malfunctioning unit start working.**

LECTROSONICS' Service Department is equipped and staffed to quickly repair your equipment. In warranty repairs are made at no charge in accordance with the terms of the warranty. Out-of-warranty repairs are charged at a modest flat rate plus parts and shipping. Since it takes almost as much time and effort to determine what is wrong as it does to make the repair, there is a charge for an exact quotation. We will be happy to quote approximate charges by phone for out-of-warranty repairs.

Returning Units for Repair

For timely service, please follow the steps below:

- A. DO NOT return equipment to the factory for repair without first contacting us by email or by phone. We need to know the nature of the problem, the model number and the serial number of the equipment. We also need a phone number where you can be reached 8 A.M. to 4 P.M. (U.S. Mountain Standard Time).
- B. After receiving your request, we will issue you a return authorization number (R.A.). This number will help speed your repair through our receiving and repair departments. The return authorization number must be clearly shown on the **outside** of the shipping container.
- C. Pack the equipment carefully and ship to us, shipping costs prepaid. If necessary, we can provide you with the proper packing materials. UPS is usually the best way to ship the units. Heavy units should be "double-boxed" for safe transport.
- D. We also strongly recommend that you insure the equipment, since we cannot be responsible for loss of or damage to equipment that you ship. Of course, we insure the equipment when we ship it back to you.

Lectrosonics USA:

Mailing address:

Lectrosonics, Inc.
PO Box 15900
Rio Rancho, NM 87174
USA

Shipping address:

Lectrosonics, Inc.
561 Laser Rd. NE, Suite 102
Rio Rancho, NM 87124
USA

Telephone:

(505) 892-4501
(800) 821-1121 Toll-free
(505) 892-6243 Fax

Web:

www.lectrosonics.com

E-mail:

sales@lectrosonics.com
service.repair@lectrosonics.com

Lectrosonics Canada:

Mailing Address:

720 Spadina Avenue,
Suite 600
Toronto, Ontario M5S 2T9

Telephone:

(416) 596-2202
(877) 753-2876 Toll-free
(877-7LECTRO)
(416) 596-6648 Fax

E-mail:

Sales: colinb@lectrosonics.com
Service: joeb@lectrosonics.com

LIMITED ONE YEAR WARRANTY

The equipment is warranted for one year from date of purchase against defects in materials or workmanship provided it was purchased from an authorized dealer. This warranty does not cover equipment which has been abused or damaged by careless handling or shipping. This warranty does not apply to used or demonstrator equipment.

Should any defect develop, Lectrosonics, Inc. will, at our option, repair or replace any defective parts without charge for either parts or labor. If Lectrosonics, Inc. cannot correct the defect in your equipment, it will be replaced at no charge with a similar new item. Lectrosonics, Inc. will pay for the cost of returning your equipment to you.

This warranty applies only to items returned to Lectrosonics, Inc. or an authorized dealer, shipping costs prepaid, within one year from the date of purchase.

This Limited Warranty is governed by the laws of the State of New Mexico. It states the entire liability of Lectrosonics Inc. and the entire remedy of the purchaser for any breach of warranty as outlined above. **NEITHER LECTROSONICS, INC. NOR ANYONE INVOLVED IN THE PRODUCTION OR DELIVERY OF THE EQUIPMENT SHALL BE LIABLE FOR ANY INDIRECT, SPECIAL, PUNITIVE, CONSEQUENTIAL, OR INCIDENTAL DAMAGES ARISING OUT OF THE USE OR INABILITY TO USE THIS EQUIPMENT EVEN IF LECTROSONICS, INC. HAS BEEN ADVISED OF THE POSSIBILITY OF SUCH DAMAGES. IN NO EVENT SHALL THE LIABILITY OF LECTROSONICS, INC. EXCEED THE PURCHASE PRICE OF ANY DEFECTIVE EQUIPMENT.**

This warranty gives you specific legal rights. You may have additional legal rights which vary from state to state.

